

# CLASSEN®

DOOR CATALOGUE

2022





CREATE  
an interior  
WITH CHARACTER



YOUR **DOORS**

SYMBOLS USED IN THE CATALOGUE ..... 6

**LACQUERED PANEL DOORS** ..... 8

LIRGO .....	10	<b>NEW!</b>
BRENTA .....	12	
VENIS .....	14	
LARIX .....	16	
LINEA .....	18	
LINEA PREMIUM .....	20	
LINEA PREMIUM LOFT .....	22	
MORANO .....	24	
GRAFEN .....	26	
SALVANO .....	28	
CLASSIC .....	30	

**VENEER FRAMED DOORS** ..... 32

CLIF .....	34	
MAGNETIC .....	36	
GRECO .....	38	
TRAFFIC .....	40	
HAVANA .....	42	
LUKKA .....	44	
TOSCA .....	46	
FERRO .....	48	
KOFANO .....	50	
ANTICA .....	52	

**VENEER PANEL DOORS** ..... 54

SAGA .....	56	
ASTERIA NL .....	58	
ASTERIA .....	60	
DISCOVERY .....	62	
TETYDA .....	64	
NATURA HR .....	66	
ANDROMEDA .....	68	
DEMETER .....	70	
ARENA .....	72	
CENTURY .....	74	
MALAGA .....	76	
MODENA 4 .....	78	
NATURA .....	80	
ANTIOPE .....	82	
TEMIDA .....	84	
SIDE PANEL .....	86	

**TECHNICAL PANEL DOORS** ..... 88

NATURA HK CPL / HB CPL .....	90	
NATURA HK HPL / HB HPL .....	92	
GUARD .....	94	
BORD .....	96	
BORD W3 .....	98	
FIRE DOORS - EI30 / EI60 .....	100	
ACOUSTIC DOORS - EI30 / 42 DB .....	102	
VENOM .....	104	
VENOM ALU .....	106	
ACOUSTIC DOORS .....	108	

**DOORS ALIGNED WITH THE WALL** ..... 110

COMPACT .....	112	
---------------	-----	--

**SLIDING DOOR SYSTEMS** ..... 114

DOUBLE LEAF SLIDING DOOR SYSTEM .....	116	
SINGLE LEAF SLIDING DOOR SYSTEM .....	117	
DIVA .....	118	
MODI DESIGN .....	120	<b>NEW!</b>
SLIDING POCKET DOOR SYSTEM - ECLISSE .....	121	

**WOOD-BASED DOOR FRAMES** ..... 122

ADJUSTABLE / ADJUSTABLE 80 .....	124	
NON-REBATED ADJUSTABLE / ADJUSTABLE 80 .....	125	
ARCUS .....	126	
NEW ARCUS .....	127	
STANDARD 2-PACK FIXED .....	128	
CMOK .....	129	

**STEEL DOOR FRAMES** ..... 130

STEEL FIXED REBATED / NON-REBATED .....	131	
STEEL ADJUSTABLE .....	132	
STEEL ADJUSTABLE NON-REBATED .....	133	

**DEDICATED DOOR FRAMES** ..... 134

BORD STEEL FIXED / CORNER FIXED .....	135	
BORD MDF FIXED .....	136	
HYBRID .....	137	
BORD W3 STEEL FIXED .....	138	
GUARD STEEL FIXED / ADJUSTABLE .....	139	
FIRE WOODEN FIXED / STEEL FIXED .....	140	
42 DB MFD FIXED NON-REBATED / REBATED .....	141	

**THE ABC OF DOORS - INFORMATION DATABASE** ..... 142

ADDITIONAL ELEMENTS .....	144	
DOOR DIMENSIONS .....	145	
MOULDINGS / RAL COLOURS .....	146	
CROWNS .....	147	
ACCESSORIES .....	148	
HANDLES .....	150	
VENEER / LACQUER .....	154	
HPL UNI DECORS .....	158	
HPL WOOD DECORS .....	159	

# SYMBOLS USED IN THE CATALOGUE

## TYPE OF DOORS

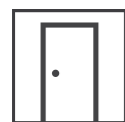

### Single leaf doors

The most frequently chosen type of doors, commonly used in construction. Depending on the collection and purpose, leaves with the width from 60 to 120 cm are used. Next to this icon, you will always find the range of available widths for the selected collection.



### Single leaf sliding doors

To open this door leaf, you need to slide it along a wall, it can also disappear completely into the wall cavity. There are several types of sliding systems available, so you can choose the one that suits your needs and interior design. Sliding doors are only available with a straight, non-rebated edge.



### Double leaf doors

A type of door used for very wide door openings. Depending on the collection and purpose, the total width of both leaves from 120 to 200 cm is used. Active and passive leaf available only in rebated version. Next to this icon, you will always find the range of available widths for the selected collection.



### Double leaf sliding doors

Two door leaves used in case of very wide door openings. There are two types of sliding systems available, so you can choose the one that suits your needs and interior design - either the on-wall or the pocket door system. Sliding doors are only available with a straight, non-rebated edge.

## TYPE OF DOOR REBATE



### Hard Edge K

Widely used, aesthetically executed edge with K rebate profile is a standard finishing of a door leaf edge. An edge with K profile is stylish and always in fashion.



### Hard Edge B

A straight edge of a non-rebated door, timeless, aesthetic and durable. This solution increases the visual value, because the door creates a uniform surface with the door frame.



### Hard Edge R

Aesthetically rounded edge with the radius of 5 mm. This practical solution guarantees not only safety to our children, but also easier maintenance.



### Hard Edge PF

The rounded edge of the door leaf with a radius of 4 mm, finished with flexible CPL laminates, obtained thanks to the modern technology of boards refinement - postforming. Characteristic features - abrasion resistance and safety.

## DOORS CONSTRUCTION AND FILLING



### Classen Hard

Reinforced peripheral frame, consisting of two construction elements: a peripheral frame made of softwood and MDF, filled with a highly specialized cardboard. This solution guarantees increased rigidity of a door leaf and resistance against warping.

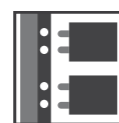

### Framed construction

It consists of single elements, made entirely of wood-based material - MDF, covered with Classen decors, joined together with the use of solid mounting pins.

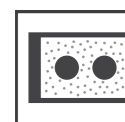

### Perforated chipboard

Construction consisting of a perforated, wood-based chipboard placed between a peripheral frame made of softwood / MDF. Such construction of a door leaf guarantees high stability and increased sound absorption.

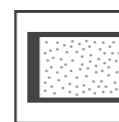

### Chipboard

Construction consisting of a solid chipboard placed between a peripheral frame made of softwood / MDF. Such construction of a door leaf guarantees a high stability and very good sound absorption.



### Honeycomb

It is a highly specialized cardboard with a construction and structure similar to a honeycomb, used as a standard stabilizing filling between construction / peripheral frame of a door leaf.



### HLT chipboard, acoustic

A construction consisting of a solid chipboard with increased acoustic parameters, placed between a peripheral frame made of softwood and plywood.

## TECHNICAL PROPERTIES



### Burglary resistance

Internal entrance doors, fulfilling the requirements of RC2 anti-burglary protection class, provide better security for your flat.



### Mechanical resistance class 3

Door leaves with increased mechanical strength, especially recommended for use in buildings with high traffic, e.g. in public utility, industrial and warehouse buildings. Recommended for kindergartens, schools and hospitals.



### Acoustic resistance

Doors with increased acoustic resistance. A guarantee of full comfort and freedom of action.



### EI30 & EI60 fire doors

Fire doors designed for use in residential housing, public utility and collective residential buildings as the internal entrance doors. Thickness of a door leaf: 50 mm (for EI 30) and 60 mm (for EI 60).

## DOOR FINISHES



### Primo

A basic group of wood veneers, impregnated, characterised by a required abrasion resistance.



### CPL

Laminate characterized by very high scratch and abrasion resistance, composed of four hot-pressed layers with the use of special adhesives, covered with a durable overlay lacquer. The main advantages include particularly high scratch and abrasion, high temperatures, UV and chemical resistance.

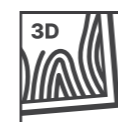

### 3D Look

Veneers with synchronous pores effect. The pores synchronized with the woodgrain pattern optically emboss it, which leads to creation of a three-dimensional effect. These decors perfectly imitate natural veneer.



### HPL

Decorative laminate, 0.8 mm thick, based on thermosetting resins. Created of several layers, which are composed of melamine decorative papers and one or more resin-impregnated reinforcing papers. They are characterized by a very high resistance to both chemical agents and mechanical damage.



### Iridium

Laminate characterized by high scratch and abrasion resistance, created in the process of hot press lamination with the use of special glues, covered with scratch resistant overlay lacquer. The main advantages include particularly high scratch and abrasion, chemical and UV resistance as well as high aesthetic value achieved due to the possibility of applying wood structure.



### PU lacquer

Smooth satin HDF surface coated with polyurethane lacquer. Our standard offer includes collections in RAL 7004 gray and RAL 9005 black. Other colours from the RAL palette (table on page 146) are available only in this lacquer quality.



### UV lacquer

HDF surface covered with primer and ecological lacquer hardened with UV rays. Standard white Lac colour is an equivalent of RAL 9003.



### UV Pure lacquer

HDF surface coated with eco-friendly lacquer and polyurethane primer, which creates a velvety smooth surface of the door leaf. Standard white Lac colour is an equivalent of RAL 9003.



### RAL palette colours

A possibility to finish the door in colours from the RAL palette as an extra-cost option, details in the table on page 146. Minimum order quantity - 3 sets (door leaf + door frame). All collections in RAL are finished in polyurethane lacquer quality.

## OTHER

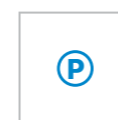

### Rebated door leaf

Supplementary marking to the above icons, indicating the type of rebate that is available with a given type of door.

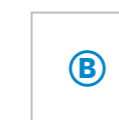

### Non-rebated door leaf

Supplementary marking to the above icons, indicating the type of rebate that is available with a given type of door.

# LACQUERED PANEL DOORS

A perfect combination of modern design and high-quality workmanship. In our collections, they most often appear in the colour of timeless white, which makes them a great means to enlarge the interior optically. The minimalism of decorations gives them an elegant character. The surface of the leaves finished with lacquer is perfectly smooth. The doors are easy to clean and maintain. They are also distinguished by high durability and resistance to damage, which makes them a good investment for years.



DO YOU PREFER SIMPLICITY AND MONOCHROMATIC COLOURS? You will find them in lacquered doors with a minimalist design. Thanks to them, you will emphasize the elegant and subdued character of your apartment.

DO YOU LOVE VIVID COLOURS? Do you feel that they express your personality? Don't give up on them! Lacquered doors will harmonize beautifully with even the craziest palette of colours, while introducing balance in the interior design.

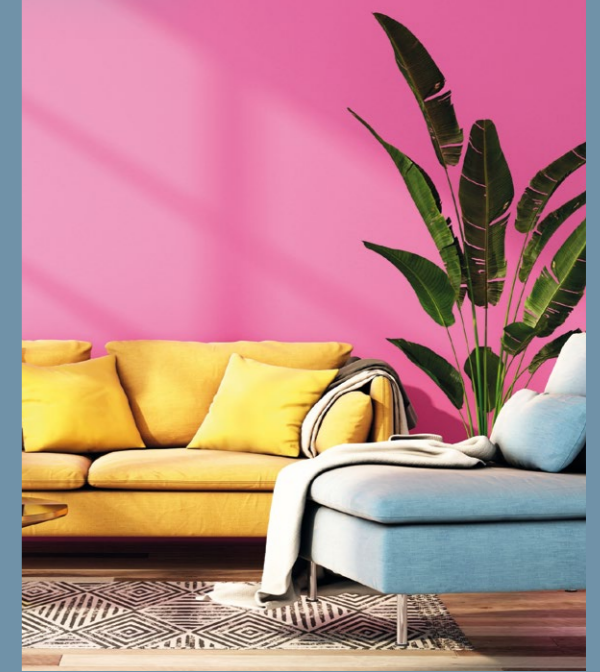



full – white

full – gray

full – black

#### MODELS

#### DETAILS



groove profile – white



groove profile – gray

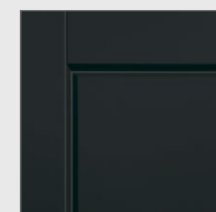

groove profile – black

#### DOOR SPECIFICATION

- peripheral frame made of MDF board, stabilizing "honeycomb" core

#### Rebated door leaf:

- two silver screw-in pintle hinges
- lock: mortice key lock / bathroom lock / cylinder lock / passage lock

#### Non-rebated door leaf:

- two openings for 3D hidden hinges
- magnetic lock: mortice key lock / bathroom lock / cylinder lock / passage lock

#### DEDICATED DOOR FRAMES

##### Hard edge K:

- standard fixed and adjustable door frame, UV white lacquered and PU black, grey lacquered

##### Hard edge B:

- non-rebated adjustable door frame, UV white lacquered and PU black, grey lacquered

#### EXTRA-COST OPTIONS

##### Ventilation:

- ventilation undercut
- ventilation undercut 15 mm (recuperation)

##### Construction:

- third hinge
- non-rebated door leaf
- sliding and passive door leaf

#### UV lacquer

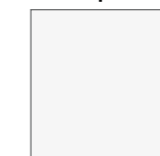

WHITE

#### PU lacquer\*



GRAY 7004



BLACK 9005

\* | Minimum order quantity in the case of gray and black models – 2 sets (door leaf + door frame).

# BRENTA

LACQUERED PANEL DOORS REBATED / NON-REBATED

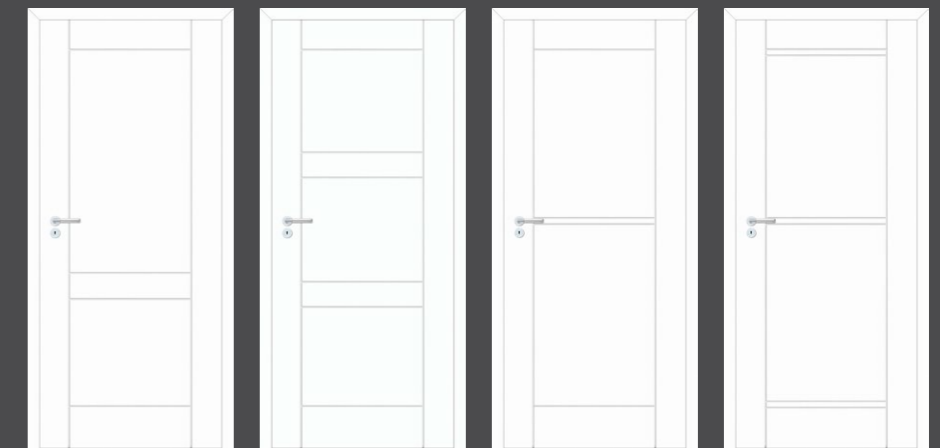
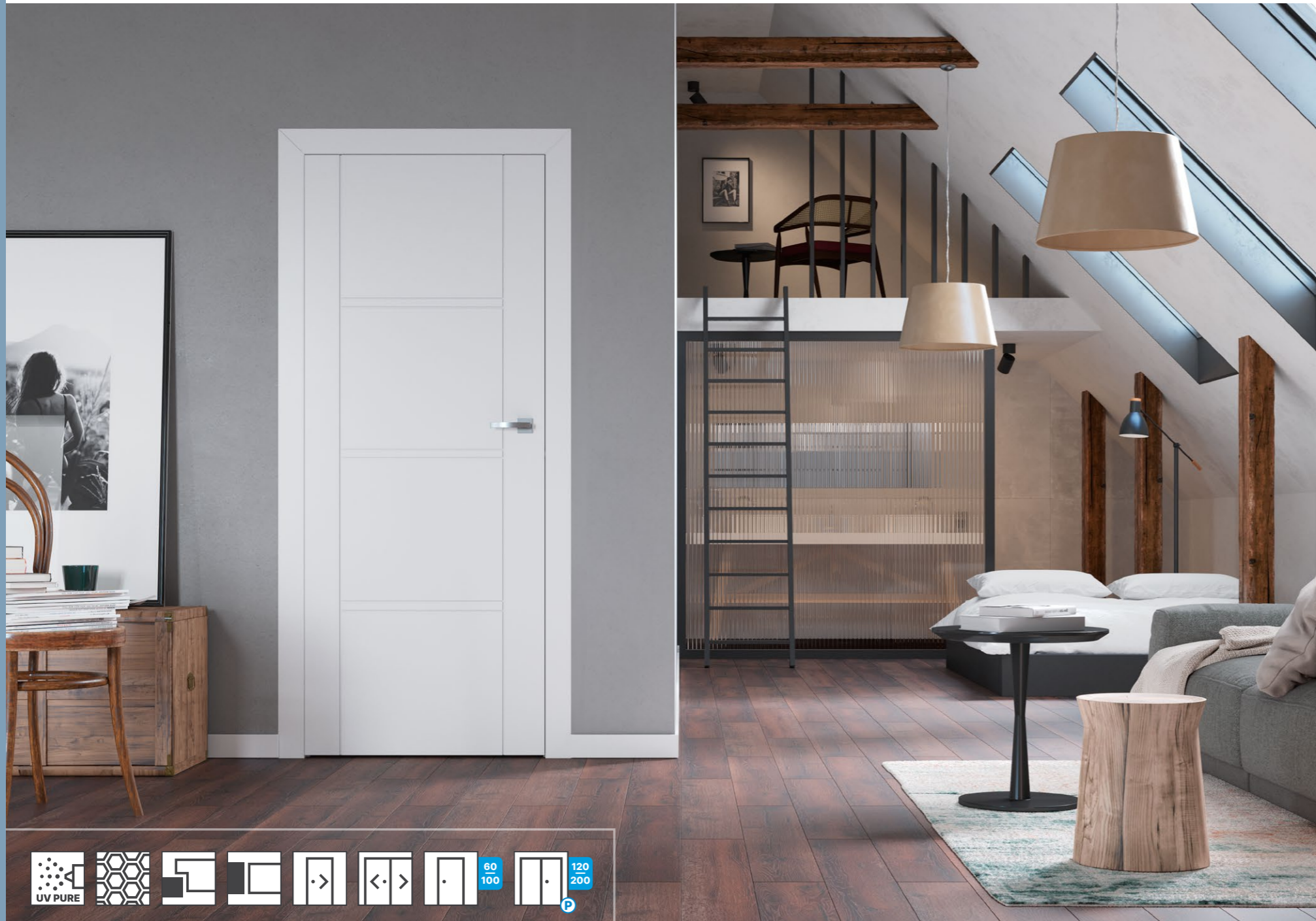

model 1      model 2      model 3      model 4

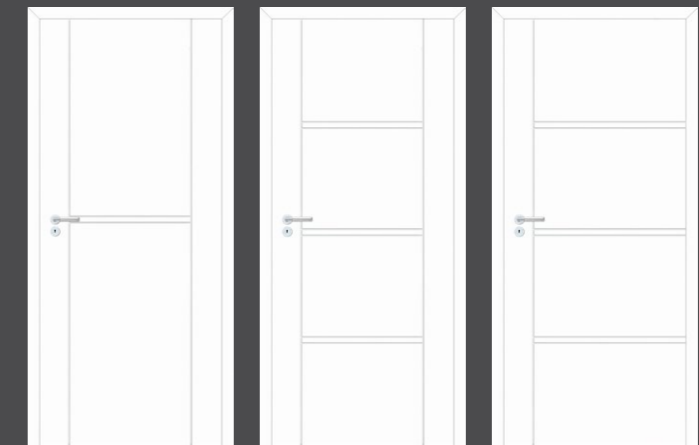

model 5      model 6      model 7

## MODELS

## DETAILS

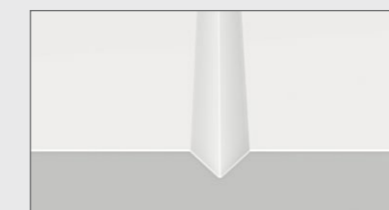

groove profile

### DOOR SPECIFICATION

- peripheral frame made of MDF board, stabilizing "honeycomb" core

#### Rebated door leaf:

- two silver screw-in pintle hinges \*
- lock: mortice key lock / bathroom lock / cylinder lock / passage lock

#### Non-rebated door leaf:

- two openings for 3D hidden hinges
- magnetic lock: mortice key lock / bathroom lock / cylinder lock / passage lock

### DEDICATED DOOR FRAMES

#### Hard edge K:

- standard fixed and adjustable door frame, UV lacquered

#### Hard edge B:

- non-rebated adjustable door frame, UV lacquered

### EXTRA-COST OPTIONS

#### Ventilation:

- ventilation undercut
- ventilation undercut 15 mm (recuperation)
- ventilation sleeves (white)

#### Construction:

- third hinge
- perforated chipboard (rebated and non-rebated)
- non-rebated door leaf
- door leaf 100'
- sliding and passive door leaf

\* | Door leaves 100' and reinforced door leaves regardless of the size – the set includes 3 hinges.

\*\* | Minimum order quantity in the case of RAL colour finish – 3 sets (door leaf + door frame).

### UV Pure lacquer



WHITE



AVAILABLE IN RAL PALETTE \*\*

# VENIS

LACQUERED PANEL DOORS REBATED / NON-REBATED



MODELS

DETAILS

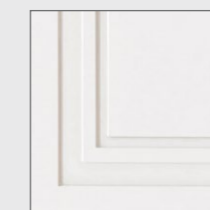

groove profile



glazing frame

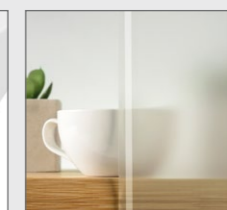

milky-white toughened safety glass with an overprint

## DOOR SPECIFICATION

- peripheral frame made of MDF board, stabilizing "honeycomb" core
- milky-white toughened safety glass with an overprint

### Rebated door leaf:

- two silver screw-in pintle hinges \*
- lock: mortice key lock / bathroom lock / cylinder lock / passage lock

### Non-rebated door leaf:

- two openings for 3D hidden hinges
- magnetic lock: mortice key lock / bathroom lock / cylinder lock / passage lock

## DEDICATED DOOR FRAMES

### Hard edge K:

- standard fixed and adjustable door frame, UV lacquered

### Hard edge B:

- non-rebated adjustable door frame, UV lacquered

## EXTRA-COST OPTIONS

### Ventilation:

- ventilation undercut
- ventilation undercut 15 mm (recuperation)
- ventilation sleeves (white)

### Construction:

- third hinge
- perforated chipboard (rebated and non-rebated)
- non-rebated door leaf
- door leaf 100'
- sliding and passive door leaf

\* | Door leaves 100' and reinforced door leaves regardless of the size - the set includes 3 hinges.

\*\* | Minimum order quantity in the case of RAL colour finish - 3 sets (door leaf + door frame).

## UV Pure lacquer



WHITE



AVAILABLE IN RAL PALETTE \*\*



# LARIX

LACQUERED PANEL DOORS REBATED / NON-REBATED



model 1

model 2

model 3

model 4

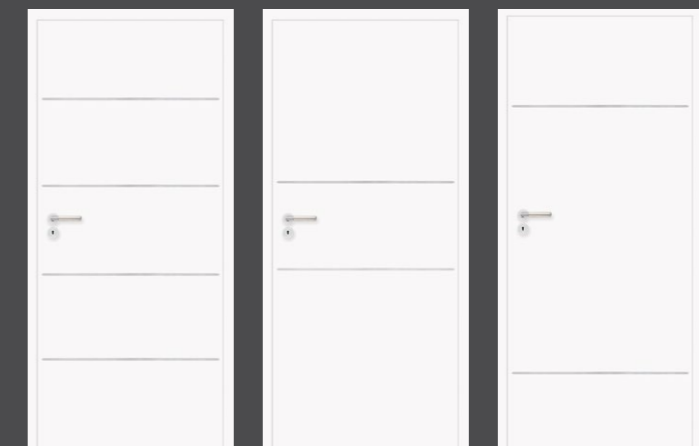

model 5

model 6

model 7

## MODELS

## DETAILS



aluminum profile

### DOOR SPECIFICATION

- peripheral frame made of MDF board, perforated chipboard core

#### Rebated door leaf:

- three silver screw-in pintle hinges
- lock: mortice key lock / bathroom lock / cylinder lock / passage lock

#### Non-rebated door leaf:

- two openings for 3D hidden hinges
- magnetic lock: mortice key lock / bathroom lock / cylinder lock / passage lock

### DEDICATED DOOR FRAMES

#### Hard edge K:

- standard fixed and adjustable door frame, UV lacquered

#### Hard edge B:

- non-rebated adjustable door frame, UV lacquered

### EXTRA-COST OPTIONS

#### Ventilation:

- ventilation undercut
- ventilation undercut 15 mm (recuperation)
- ventilation sleeves (white)

#### Construction:

- non-rebated door leaf
- door leaf 100'
- sliding and passive door leaf

### UV Pure lacquer



WHITE



AVAILABLE IN RAL PALETTE\*

\* | Minimum order quantity in the case of RAL colour finish - 3 sets (door leaf + door frame).



MODELS

DETAILS

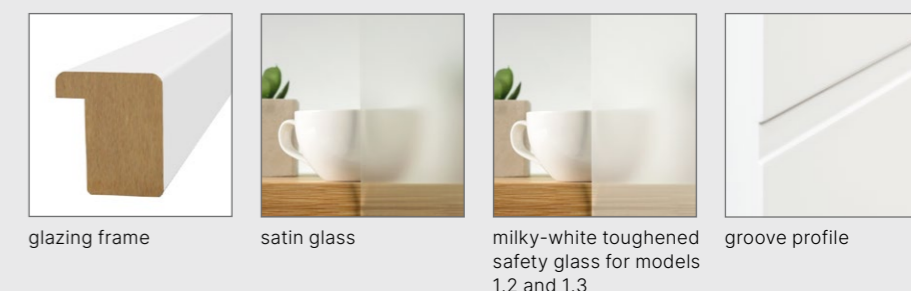

**DOOR SPECIFICATION**

- peripheral frame made of MDF board, stabilizing "honeycomb" core
- satin glass \*
- glazing frame veneer with Primo – white decor

**Rebated door leaf:**

- two silver screw-in pintle hinges \*\*
- lock: mortice key lock / bathroom lock / cylinder lock / passage lock

**Non-rebated door leaf:**

- two openings for 3D hidden hinges
- magnetic lock: mortice key lock / bathroom lock / cylinder lock / passage lock

**DEDICATED DOOR FRAMES**

**Hard edge K:**

- standard fixed and adjustable door frame, UV lacquered

**Hard edge B:**

- non-rebated adjustable door frame, UV lacquered

**EXTRA-COST OPTIONS**

**Ventilation:**

- ventilation undercut
- ventilation undercut 15 mm (recuperation)
- ventilation sleeves (white)

**Construction:**

- third hinge
- perforated chipboard (rebated and non-rebated)
- non-rebated door leaf
- door leaf 100'
- sliding and passive door leaf

\* | Except for model 1.2 – milky-white toughened glass with horizontal, transparent stripes.  
 \*\* | Door leaves 100' and reinforced door leaves regardless of the size – the set includes 3 hinges.  
 \*\*\* | Minimum order quantity in the case of RAL colour finish – 3 sets (door leaf + door frame).

**UV lacquer**



WHITE



AVAILABLE IN RAL PALETTE \*\*\*

# LINEA PREMIUM

LACQUERED PANEL DOORS REBATED / NON-REBATED



MODELS

DETAILS



groove profile

## DOOR SPECIFICATION

- peripheral frame made of MDF board, stabilizing "honeycomb" core
- Rebated door leaf:**
  - two silver screw-in pintle hinges \*
  - lock: mortice key lock / bathroom lock / cylinder lock / passage lock
- Non-rebated door leaf:**
  - two openings for 3D hidden hinges
  - magnetic lock: mortice key lock / bathroom lock / cylinder lock / passage lock

## DEDICATED DOOR FRAMES

- Hard edge K:**
  - standard fixed and adjustable door frame, UV lacquered
- Hard edge B:**
  - non-rebated adjustable door frame, UV lacquered

## EXTRA-COST OPTIONS

- Ventilation:**
  - ventilation undercut
  - ventilation undercut 15 mm (recuperation)
  - ventilation sleeves (white)
- Construction:**
  - third hinge
  - perforated chipboard (rebated and non-rebated)
  - non-rebated door leaf
  - door leaf 100'
  - sliding and passive door leaf

UV Pure lacquer



WHITE



AVAILABLE IN RAL PALETTE \*\*

\* | Door leaves 100' and reinforced door leaves regardless of the size – the set includes 3 hinges.  
 \*\* | Minimum order quantity in the case of RAL colour finish – 3 sets (door leaf + door frame).

# LINEA PREMIUM LOFT

LACQUERED PANEL DOORS REBATED / NON-REBATED

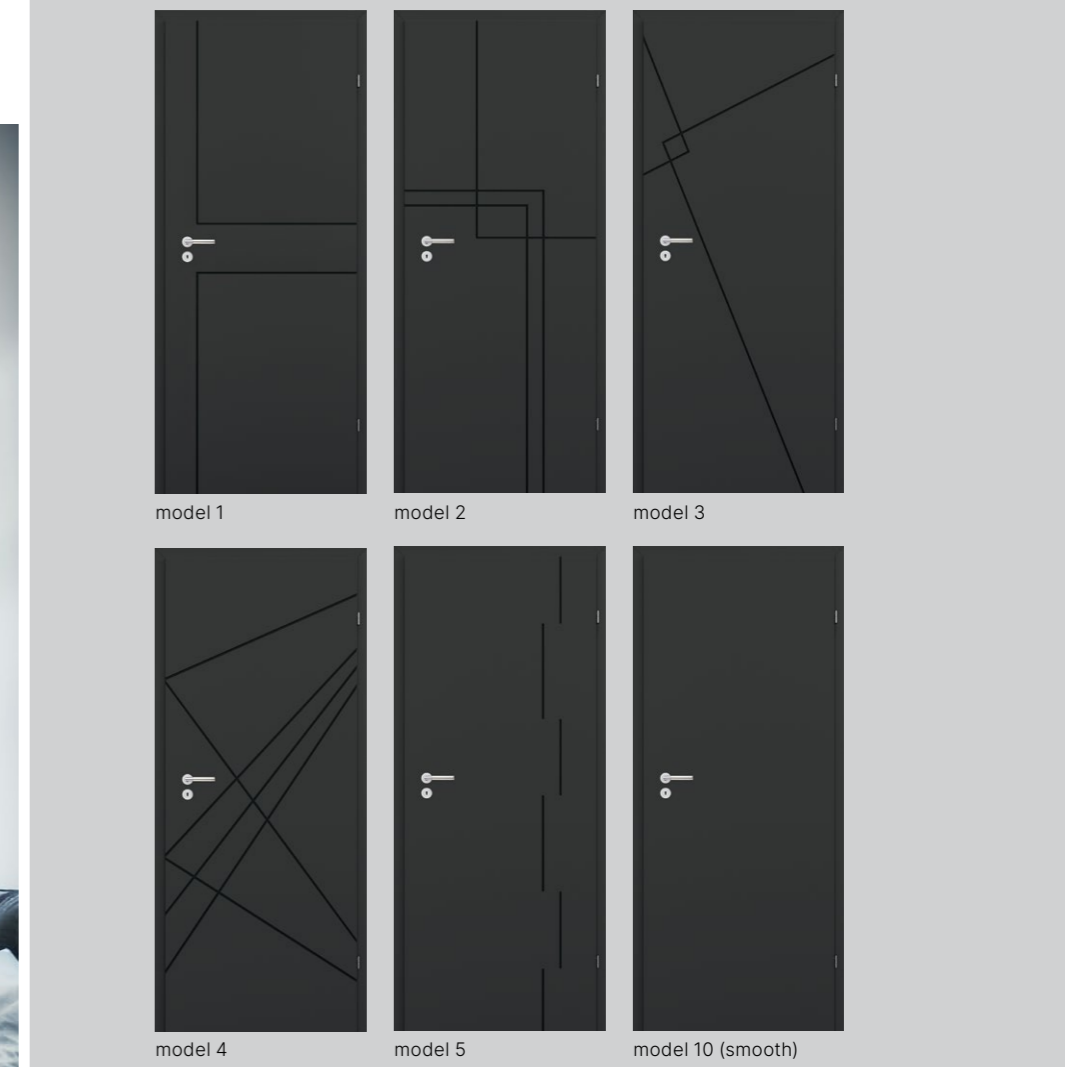

MODELS

DETAILS

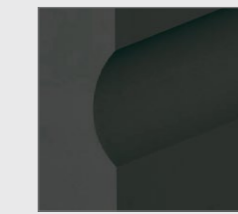

groove profile

PU lacquer



9005 BLACK MATT

## DOOR SPECIFICATION

- peripheral frame made of MDF board, stabilizing "honeycomb" core
- Rebated door leaf:**
  - two silver screw-in pintle hinges \*
  - lock: mortice key lock / bathroom lock / cylinder lock / passage lock
- Non-rebated door leaf:**
  - two openings for 3D hidden hinges
  - magnetic lock: mortice key lock / bathroom lock / cylinder lock / passage lock

## DEDICATED DOOR FRAMES

- Hard edge K:**
  - standard fixed and adjustable door frame, PU lacquered
- Hard edge B:**
  - non-rebated adjustable door frame, PU lacquered

## ADDITIONAL INFORMATION

- min. order quantity – 2 sets

## EXTRA-COST OPTIONS

- Ventilation:**
  - ventilation undercut
  - ventilation undercut 15 mm (recuperation)
  - ventilation sleeves (graphite)
- Construction:**
  - third hinge
  - perforated chipboard (rebated and non-rebated)
  - non-rebated door leaf
  - door leaf 100'
  - sliding and passive door leaf
- Finish:**
  - door frames: extra-cost of PU lacquer, acc. to RAL table, group III (page 146)

\* | Door leaves 100' and reinforced door leaves regardless of the size – the set includes 3 hinges.

# MORANO

LACQUERED PANEL DOORS REBATED / NON-REBATED

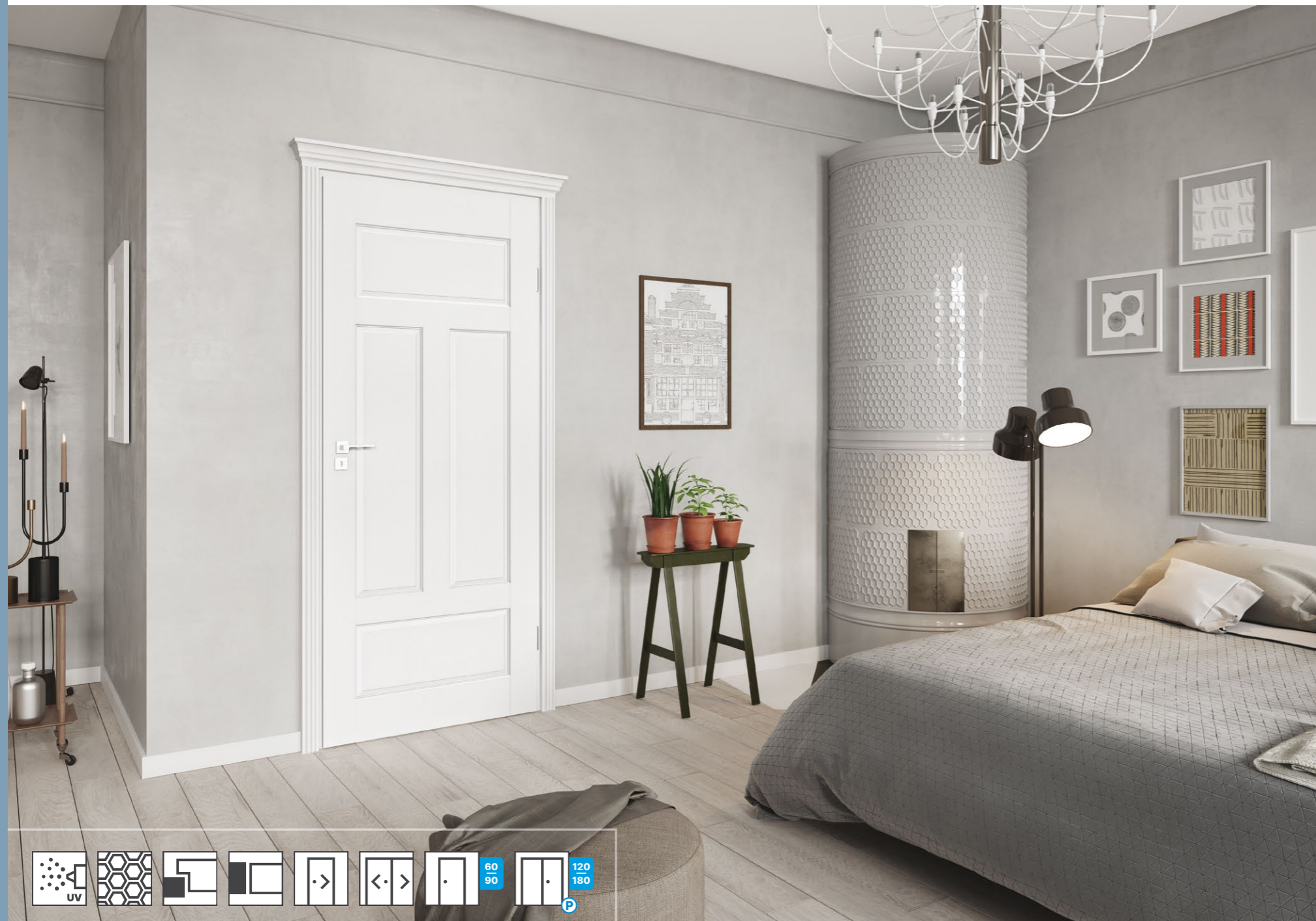

MODELS

DETAILS



glazing frame      groove profile      satin glass      transparent glass, optional for the following models: 1.4, 1.5, 2.3, 2.4, 2.5

## DOOR SPECIFICATION

- peripheral frame made of MDF board, stabilizing "honeycomb" core
- satin glass
- glazing frame veneer with Primo – white decor, except for models 2.7-2.10 (lacquered frame)

### Rebated door leaf:

- two silver screw-in pintle hinges
- lock: mortice key lock / bathroom lock / cylinder lock / passage lock

### Non-rebated door leaf:

- two openings for 3D hidden hinges
- magnetic lock: mortice key lock / bathroom lock / cylinder lock / passage lock

## DEDICATED DOOR FRAMES

### Hard edge K:

- standard fixed and adjustable door frame, UV lacquered

### Hard edge B:

- non-rebated adjustable door frame, UV lacquered

## EXTRA-COST OPTIONS

### Ventilation:

- ventilation undercut
- ventilation undercut 15 mm (recuperation)
- ventilation sleeves (white)

### Construction:

- third hinge
- non-rebated door leaf
- sliding and passive door leaf

### Glazing:

- transparent glass for the following models: 1.4, 1.5, 2.3, 2.4, 2.5 (NEW)

## UV lacquer



WHITE



AVAILABLE IN RAL PALETTE

\* | Minimum order quantity in the case of RAL colour finish – 3 sets (door leaf + door frame).

# GRAFEN

LACQUERED PANEL DOORS REBATED / NON-REBATED

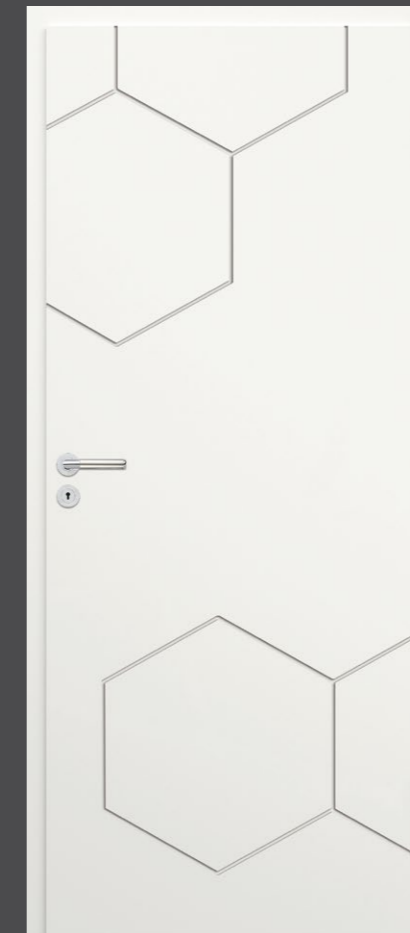
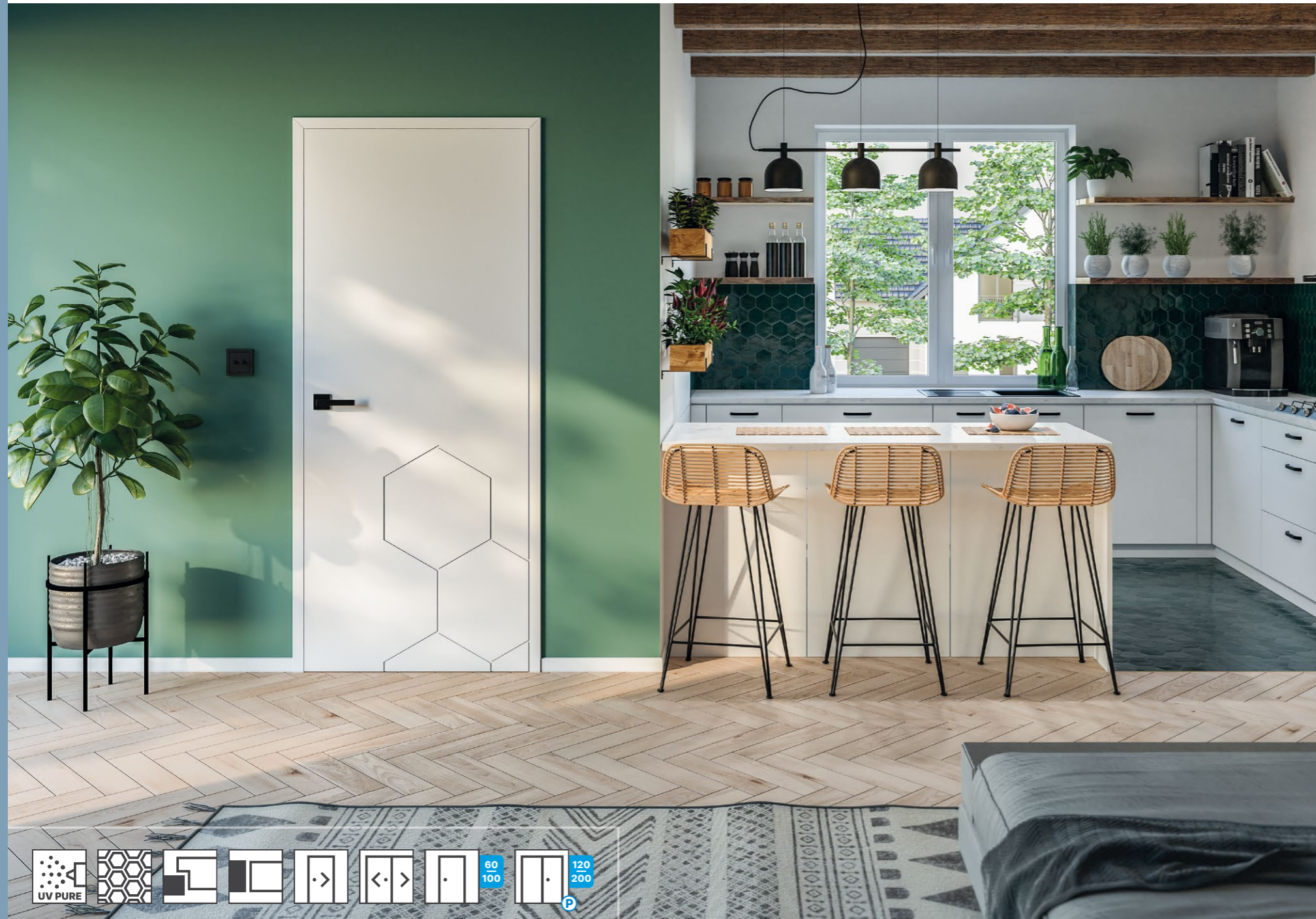

model 1



model 2



model 3



model 4

## MODELS

## DETAILS

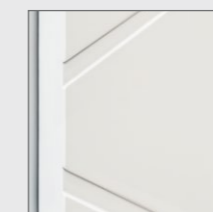

groove profile

### DOOR SPECIFICATION

- peripheral frame made of MDF board, stabilizing "honeycomb" core

#### Rebated door leaf:

- two silver screw-in pintle hinges \*
- lock: mortice key lock / bathroom lock / cylinder lock / passage lock

#### Non-rebated door leaf:

- two openings for 3D hidden hinges
- magnetic lock: mortice key lock / bathroom lock / cylinder lock / passage lock

### DEDICATED DOOR FRAMES

#### Hard edge K:

- standard fixed and adjustable door frame, UV lacquered

#### Hard edge B:

- non-rebated adjustable door frame, UV lacquered

### EXTRA-COST OPTIONS

#### Ventilation:

- ventilation undercut
- ventilation undercut 15 mm (recuperation)
- ventilation sleeves (white)

#### Construction:

- third hinge
- perforated chipboard (rebated and non-rebated)
- non-rebated door leaf
- door leaf 100'
- sliding and passive door leaf

\* | Door leaves 100' and reinforced door leaves regardless of the size – the set includes 3 hinges.

\*\* | Minimum order quantity in the case of RAL colour finish – 3 sets (door leaf + door frame).

### UV Pure lacquer



WHITE



AVAILABLE IN RAL PALETTE \*\*

# SALVANO

LACQUERED PANEL DOORS REBATED / NON-REBATED



MODELS

DETAILS

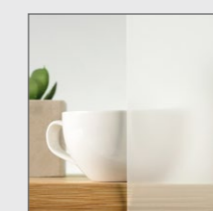

milky-white toughened safety glass

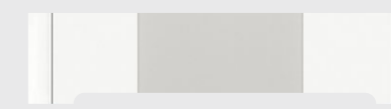

ventilation undercut for all models

## DOOR SPECIFICATION

- peripheral frame made of softwood, perforated chipboard core
- milky-white toughened safety glass

### Rebated door leaf:

- three silver screw-in pintle hinges
- lock: mortice key lock / bathroom lock / cylinder lock / passage lock

### Non-rebated door leaf:

- two openings for 3D hidden hinges
- magnetic lock: mortice key lock / bathroom lock / cylinder lock / passage lock

## DEDICATED DOOR FRAMES

### Hard edge K:

- standard fixed and adjustable door frame, UV lacquered

### Hard edge B:

- non-rebated adjustable door frame, UV lacquered

## EXTRA-COST OPTIONS

### Ventilation:

- ventilation undercut

### Construction:

- non-rebated door leaf
- door leaf 100'

## UV Pure lacquer



WHITE



AVAILABLE IN RAL PALETTE\*

\* | Minimum order quantity in the case of RAL colour finish – 3 sets (door leaf + door frame).

# CLASSIC

LACQUERED PANEL DOORS REBATED



MODELS

DETAILS



ornamental glass, transparent bark



glazing frame



door structure

UV lacquer



STRUCTURE EFFECT WHITE

## DOOR SPECIFICATION

- peripheral frame made of MDF board, stabilizing honeycomb core
- ornamental glass, transparent bark

### Rebated door leaf:

- two silver screw-in pintle hinges
- lock: mortice key lock / bathroom lock / cylinder lock / passage lock

## DEDICATED DOOR FRAMES

### Hard edge K:

- standard fixed and adjustable door frame, UV lacquered

## EXTRA-COST OPTIONS

### Ventilation:

- ventilation sleeves, white
- ventilation undercut
- ventilation grille

### Construction:

- third hinge
- passive door leaf





## veneer framed doors

Classics at its best. A great proposition for those who choose timeless elegance instead of succumbing to seasonal fashions. The framed construction provides the leaves with stability and increased resistance to damage. Inside the strong frame there are various types of fillings, including coffers, glazing, HDF panels and even mirrors. The variety of available models not only provides a real feast for the eye, but also a comfort of choosing for future users. Choosing the door that best suits individual preferences and is precisely tailored to the needs of the buyers.



DO YOU WANT TO WARM UP THE DECOR? Wood will be great for this. Not only on the floor, but also on the door leaves. Wood-like veneers with a three-dimensional structure will enhance the feeling of coziness.

INTERIOR CLOSE TO NATURE. Live plants, woven baskets and ecological decorations create a wonderful atmosphere. It will be complemented by wood structure framed door, which you can easily adapt to the colour scheme of your apartment.



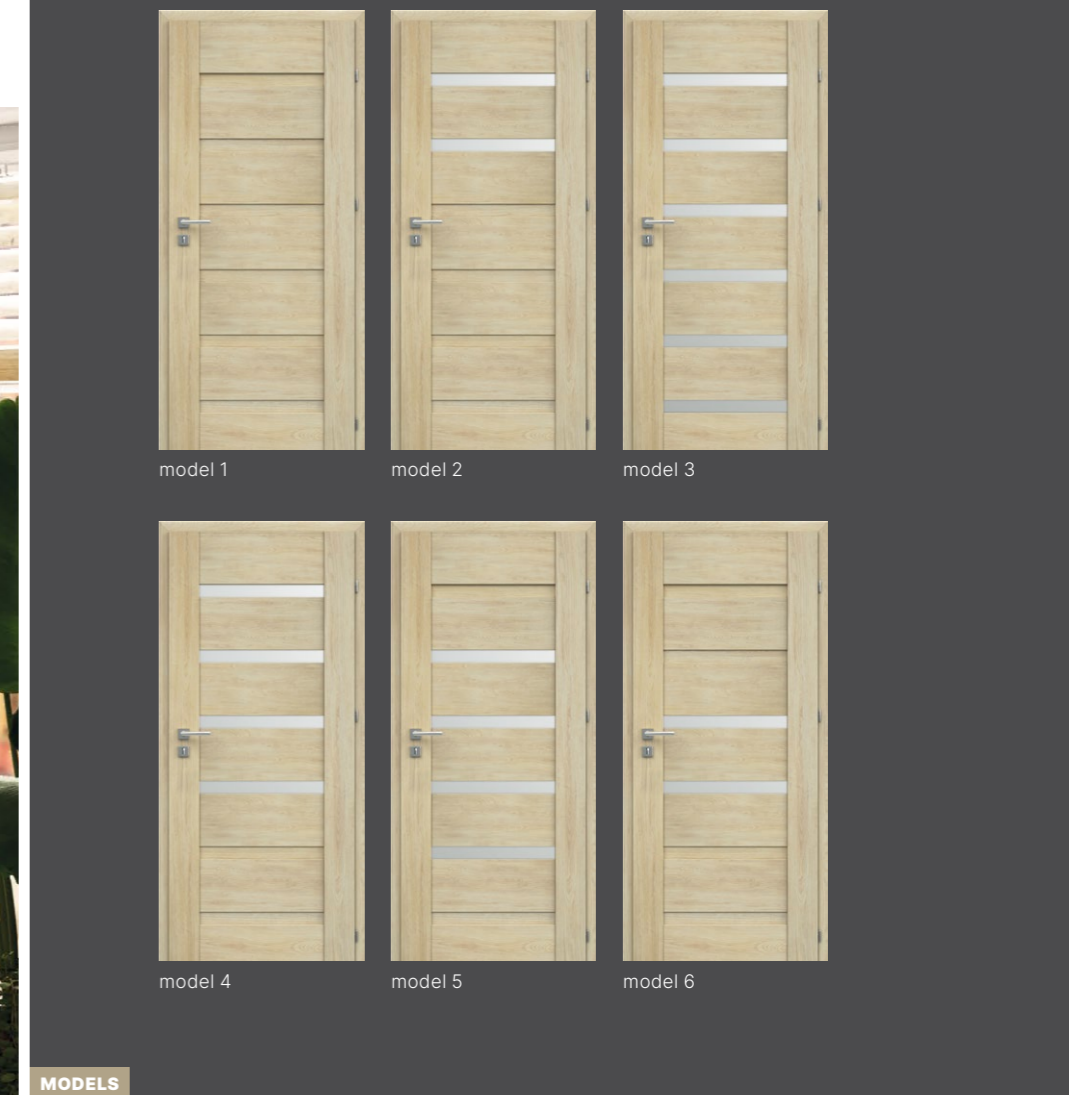

MODELS

DETAILS



satin glass

### DOOR SPECIFICATION

- frame elements made of MDF board
- satin glass or HDF panel in the door leaf colour, thickness 4 mm

### Rebated door leaf:

- three silver screw-in hinges
- lock: mortice key lock / bathroom lock / cylinder lock / passage lock

### DEDICATED DOOR FRAMES

#### Hard edge K:

- fixed and adjustable door frames for rebated doors

### EXTRA-COST OPTIONS

#### Ventilation:

- ventilation undercut
- ventilation undercut 15 mm (recuperation)

#### Construction:

- door leaf 100'
- sliding and passive door leaf

### 3D LOOK



COLOMBIA LIGHT WALNUT



CATANIA OAK



MARONE OAK



GRAY MATT



NORWEGIAN ASH

### IRIDIUM

### CPL

# MAGNETIC

VENEER FRAMED DOORS REBATED



model 1      model 2      model 3      model 4



model 5      model 6      model 7      model 8

MODELS

DETAILS



satin glass



## DOOR SPECIFICATION

- frame elements made of MDF board
- satin glass or HDF panel in the door leaf colour, thickness 4 mm

### Rebated door leaf:

- three silver screw-in hinges
- lock: mortice key lock / bathroom lock / cylinder lock / passage lock

## DEDICATED DOOR FRAMES

### Hard edge K:

- fixed and adjustable door frames for rebated doors

## EXTRA-COST OPTIONS

### Ventilation:

- ventilation undercut
- ventilation undercut 15 mm (recuperation)

### Construction:

- door leaf 100'
- sliding and passive door leaf

## 3D LOOK

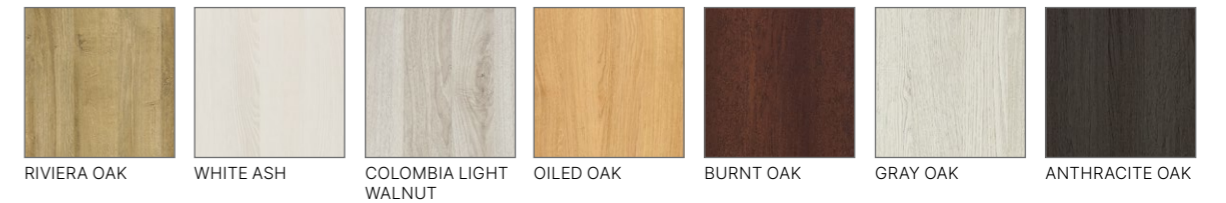

## 3D LOOK



## IRIDIUM

## CPL

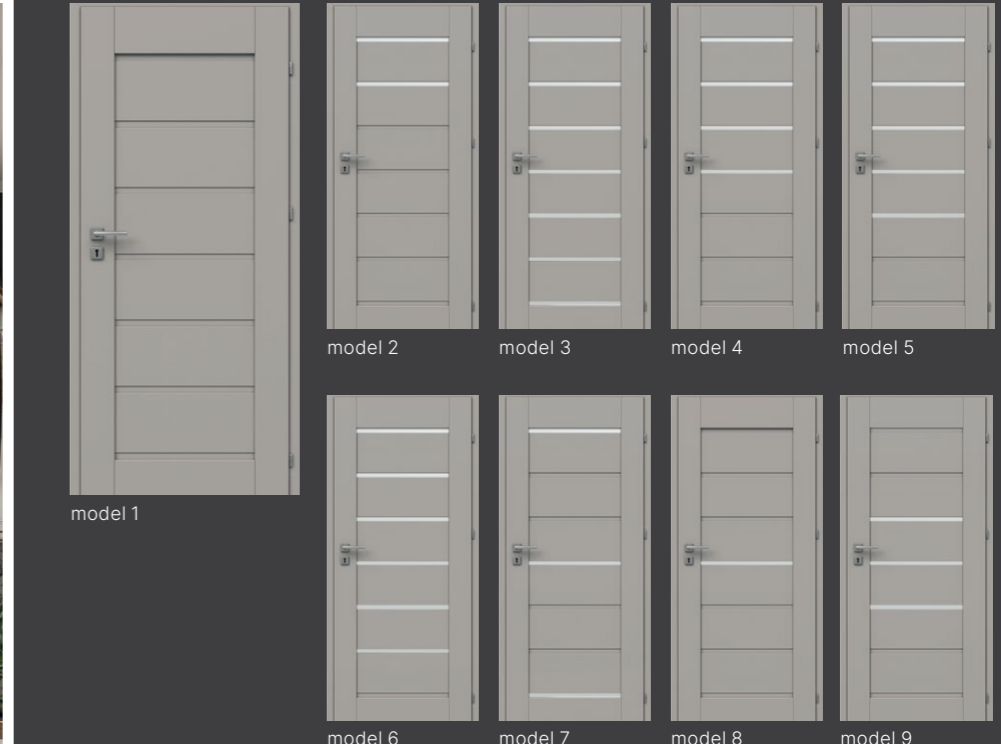
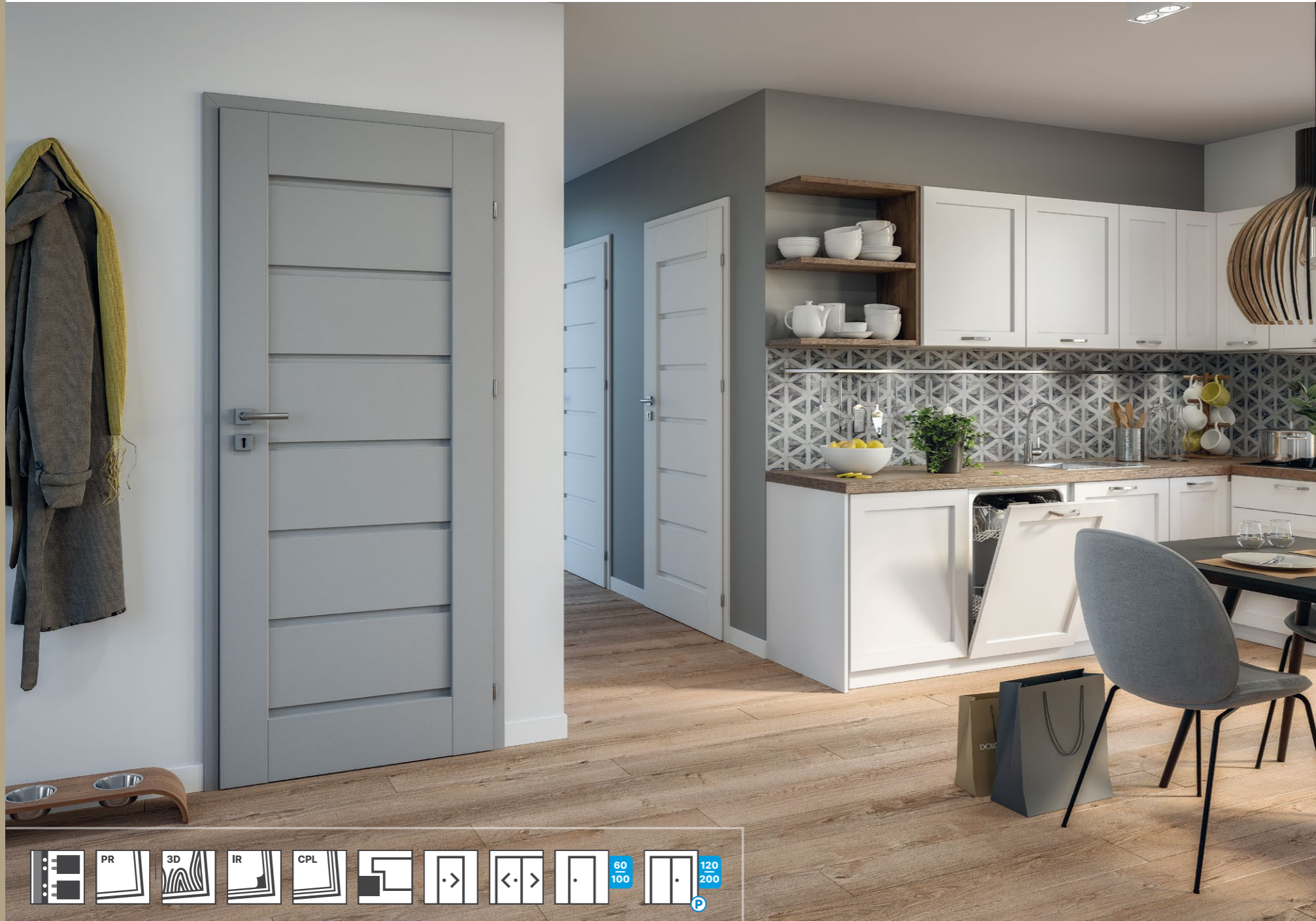

MODELS

DETAILS



satin glass

**DOOR SPECIFICATION**

- frame elements made of MDF board
- satin glass or HDF panel in the door leaf colour, thickness 4 mm

**Rebated door leaf:**

- three silver screw-in hinges
- lock: mortice key lock / bathroom lock / cylinder lock / passage lock

**DEDICATED DOOR FRAMES**

**Hard edge K:**

- fixed and adjustable door frames for rebated doors

**EXTRA-COST OPTIONS**

**Ventilation:**

- ventilation undercut
- ventilation undercut 15 mm (recuperation)

**Construction:**

- door leaf 100'
- sliding and passive door leaf

**3D LOOK**

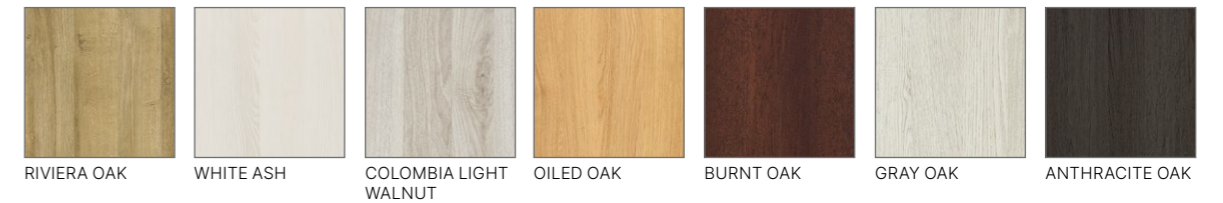

**3D LOOK**

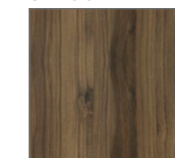

CATANIA OAK

**IRIDIUM**

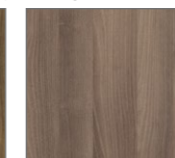

GRAPHITE ASH



MARONE OAK



WHITE MATT

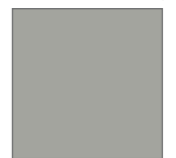

GRAY MATT

**CPL**



NORWEGIAN ASH

# TRAFFIC

VENEER FRAMED DOORS REBATED



model 1      model 2      model 3      model 4



model 5      model 6      model 7      model 8

**MODELS**

**DETAILS**



satin glass

**DOOR SPECIFICATION**

- frame elements made of MDF board
- satin glass or HDF panel in the door leaf colour, thickness 4 mm

**Rebated door leaf:**

- three silver screw-in hinges
- lock: mortice key lock / bathroom lock / cylinder lock / passage lock

**DEDICATED DOOR FRAMES**

**Hard edge K:**

- fixed and adjustable door frames for rebated doors

**EXTRA-COST OPTIONS**

**Ventilation:**

- ventilation undercut
- ventilation undercut 15 mm (recuperation)

**Construction:**

- door leaf 100'
- sliding and passive door leaf

**3D LOOK**

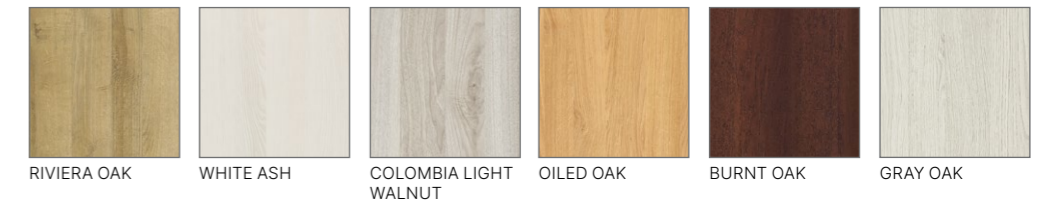

**3D LOOK**

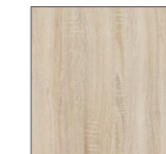

SONOMA OAK

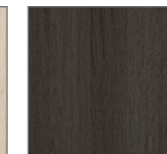

ANTHRACITE OAK

**IRIDIUM**

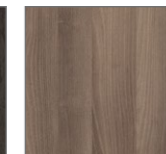

GRAPHITE ASH



WHITE MATT

**CPL**



NORWEGIAN ASH

# HAVANA

VENEER FRAMED DOORS REBATED

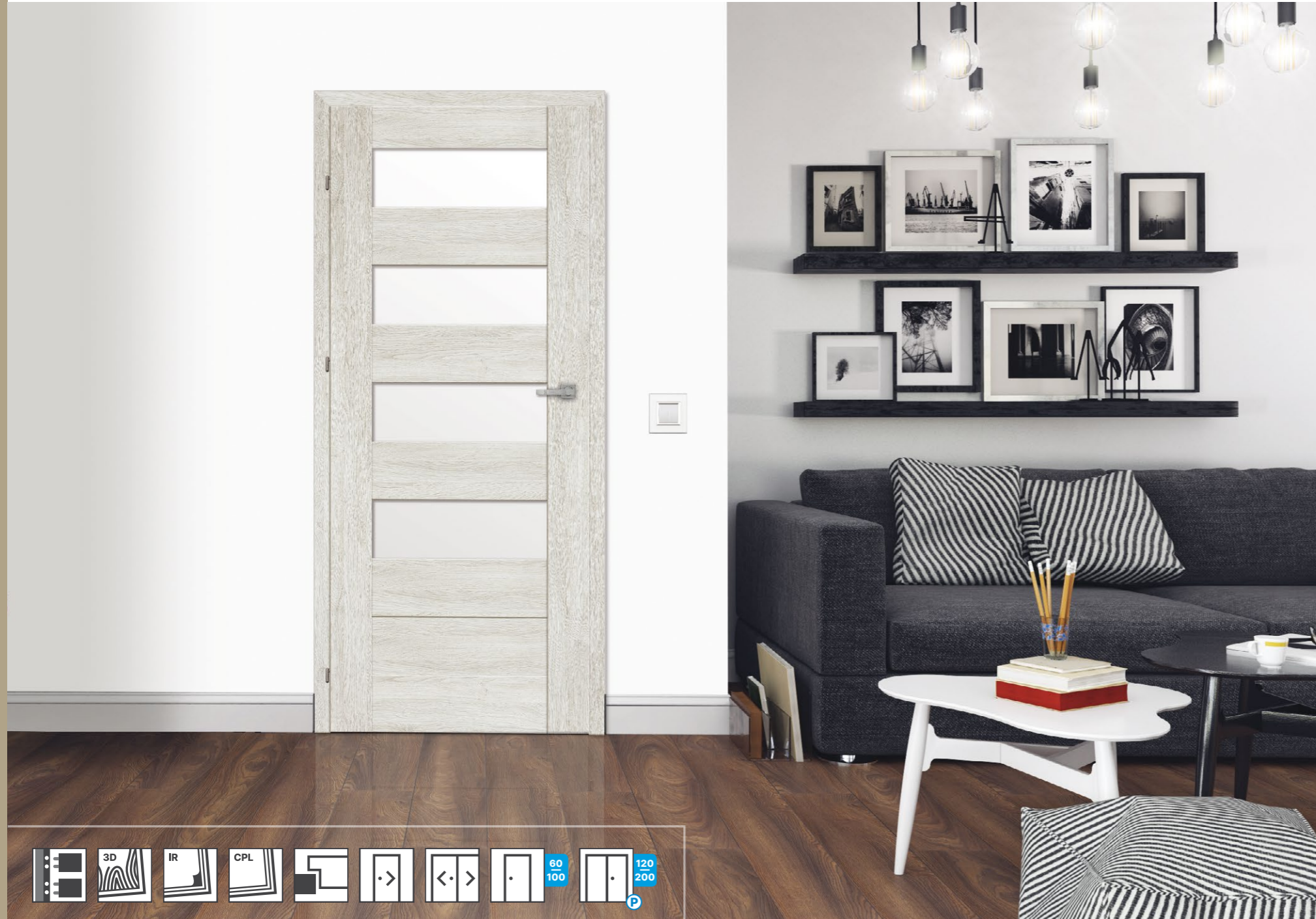

model 1      model 2      model 3      model 4



model 5      model 6      model 7

MODELS

DETAILS



satin glass



## DOOR SPECIFICATION

- frame elements made of MDF board
- satin glass or HDF panel in the door leaf colour, thickness 4 mm

### Rebated door leaf:

- three silver screw-in hinges
- lock: mortice key lock / bathroom lock / cylinder lock / passage lock

## DEDICATED DOOR FRAMES

### Hard edge K:

- fixed and adjustable door frames for rebated doors

## EXTRA-COST OPTIONS

### Ventilation:

- ventilation undercut
- ventilation undercut 15 mm (recuperation)

### Construction:

- door leaf 100'
- sliding and passive door leaf

## 3D LOOK

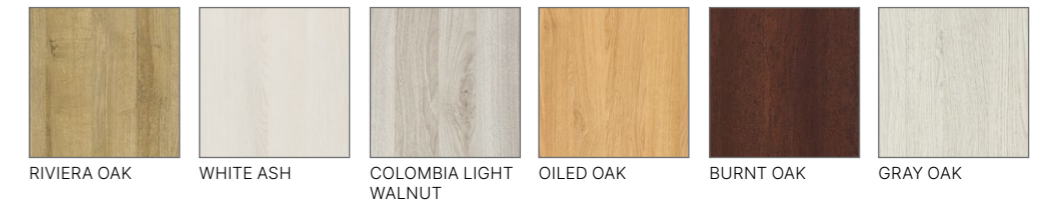

## 3D LOOK



## IRIDIUM



## CPL





# TOSCA

VENEER FRAMED DOORS REBATED



model 1      model 2      model 3      model 4



model 5      model 6      model 7      model 8

MODELS

DETAILS



satin glass

## DOOR SPECIFICATION

- frame elements made of MDF board
- satin glass or HDF panel in the door leaf colour, thickness 4 mm

### Rebated door leaf:

- three silver screw-in hinges
- lock: mortice key lock / bathroom lock / cylinder lock / passage lock

## DEDICATED DOOR FRAMES

### Hard edge K:

- fixed and adjustable door frames for rebated doors

## EXTRA-COST OPTIONS

### Ventilation:

- ventilation undercut
- ventilation undercut 15 mm (recuperation)

### Construction:

- door leaf 100'
- sliding and passive door leaf

## 3D LOOK



RIVIERA OAK      WHITE ASH      COLOMBIA LIGHT WALNUT      OILED OAK      BURNT OAK      GRAY OAK

## 3D LOOK

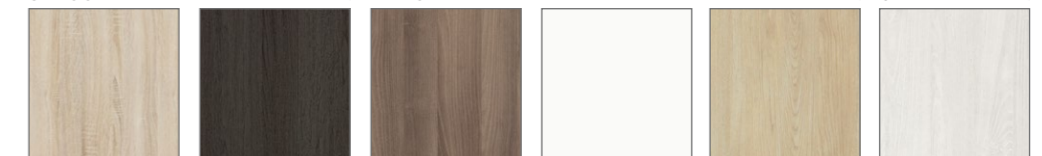

SONOMA OAK      ANTHRACITE OAK      GRAPHITE ASH      WHITE MATT      MARONE OAK      NORWEGIAN ASH

## IRIDIUM

## CPL



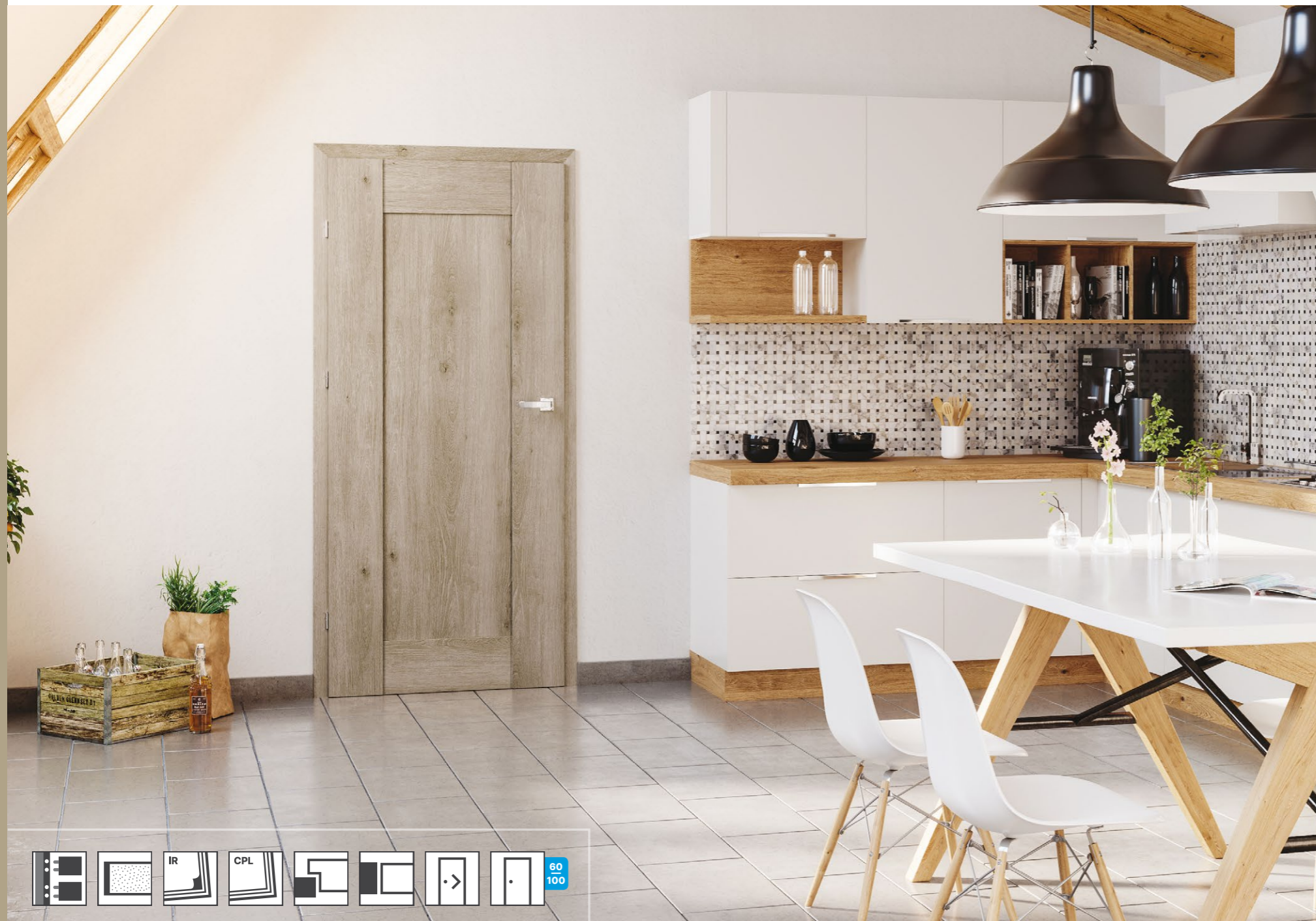

MODELS

DETAILS

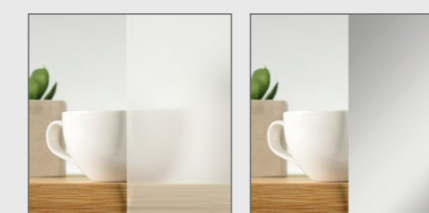

milky-white toughened safety glass    mirror safety glass

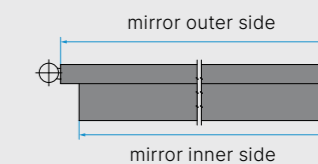

## DOOR SPECIFICATION

- frame elements: peripheral frame made of softwood, chipboard core
- milky-white toughened safety glass or a board with the thickness of 17 mm
- model 3 with a mirror, on inner or outer side

### Rebated door leaf:

- three silver screw-in hinges
- lock: mortice key lock / bathroom lock / cylinder lock / passage lock

### Non-rebated door leaf:

- two openings for 3D hidden hinges
- magnetic lock: mortice key lock / bathroom lock / cylinder lock / passage lock

## DEDICATED DOOR FRAMES

### Hard edge K:

- fixed and adjustable door frames for rebated doors

### Hard edge B:

- adjustable non-rebated door frame

## EXTRA-COST OPTIONS

### Ventilation:

- ventilation undercut
- ventilation undercut 15 mm (recuperation)

### Construction:

- non-rebated door leaf
- door leaf 100'
- sliding door leaf

## IRIDIUM

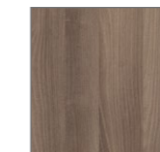

GRAPHITE ASH

## CPL

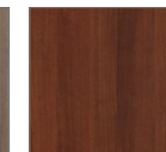

ITALIAN WALNUT



LIGHT ACACIA



NORWEGIAN ASH



GRIGIO OAK

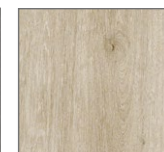

KENDAL OAK

# KOFANO

VENEER FRAMED DOORS REBATED

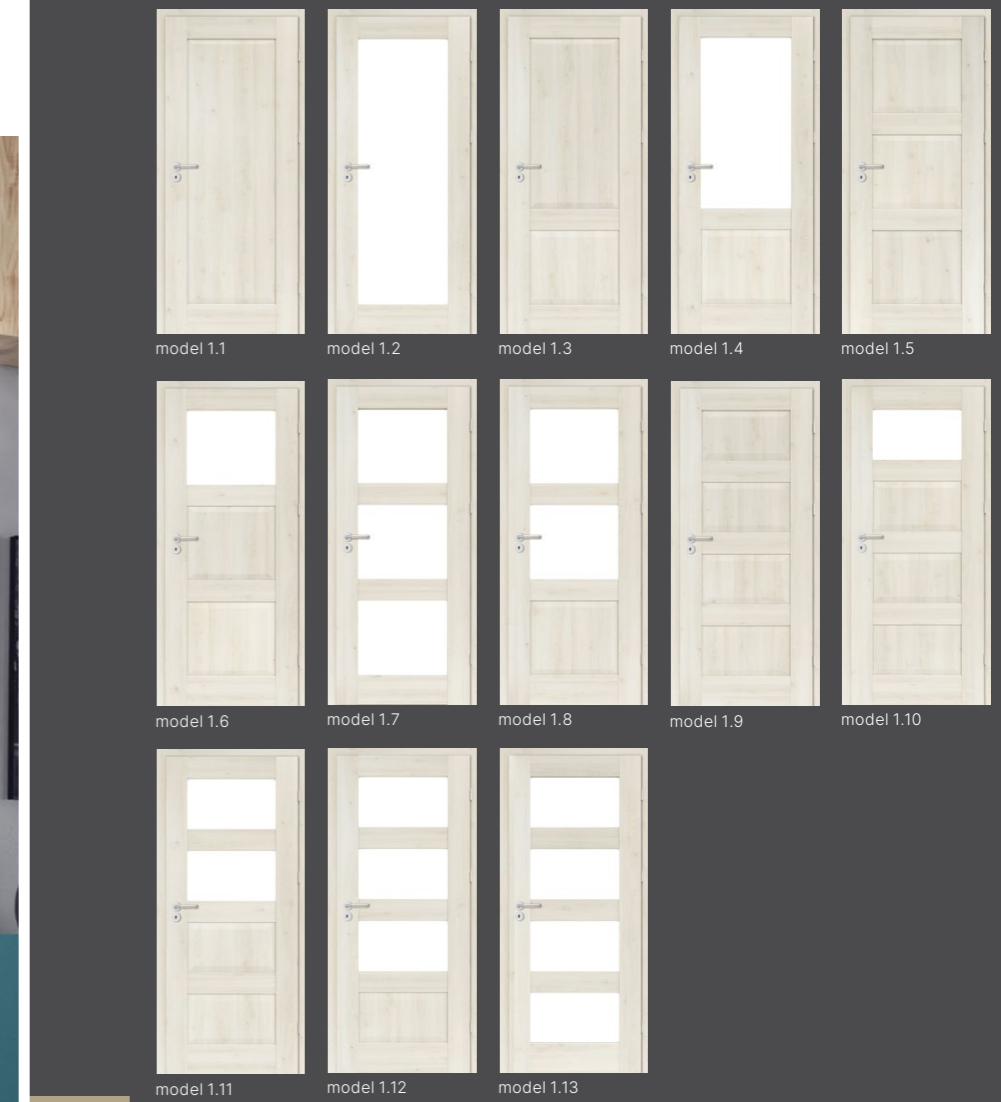

MODELS

DETAILS

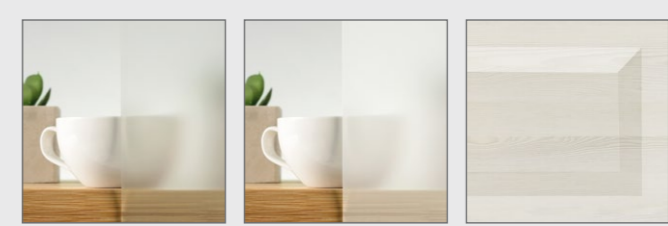

satin glass      milky-white toughened safety glass (model: 1.2, 1.4)      coffering profile

## DOOR SPECIFICATION

- frame elements made of MDF board
- satin glass, thickness 4 mm (milky-white toughened glass for models 1.2 and 1.4) or coffering

### Rebated door leaf:

- three silver screw-in hinges
- lock: mortice key lock / bathroom lock / cylinder lock / passage lock

## DEDICATED DOOR FRAMES

### Hard edge K:

- fixed and adjustable door frames for rebated doors

## EXTRA-COST OPTIONS

### Ventilation:

- ventilation undercut
- ventilation undercut 15 mm (recuperation)

### Construction:

- door leaf 100'
- sliding and passive door leaf

## 3D LOOK

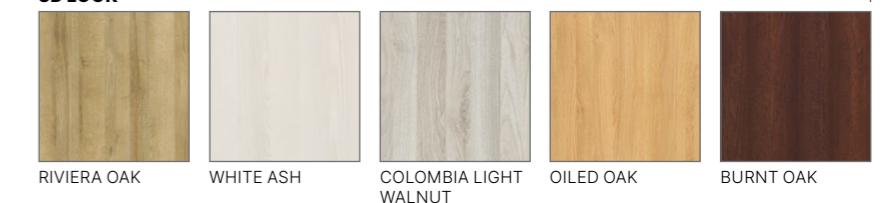

## 3D LOOK



## IRIDIUM

## CPL

# ANTICA

VENEER FRAMED DOORS REBATED

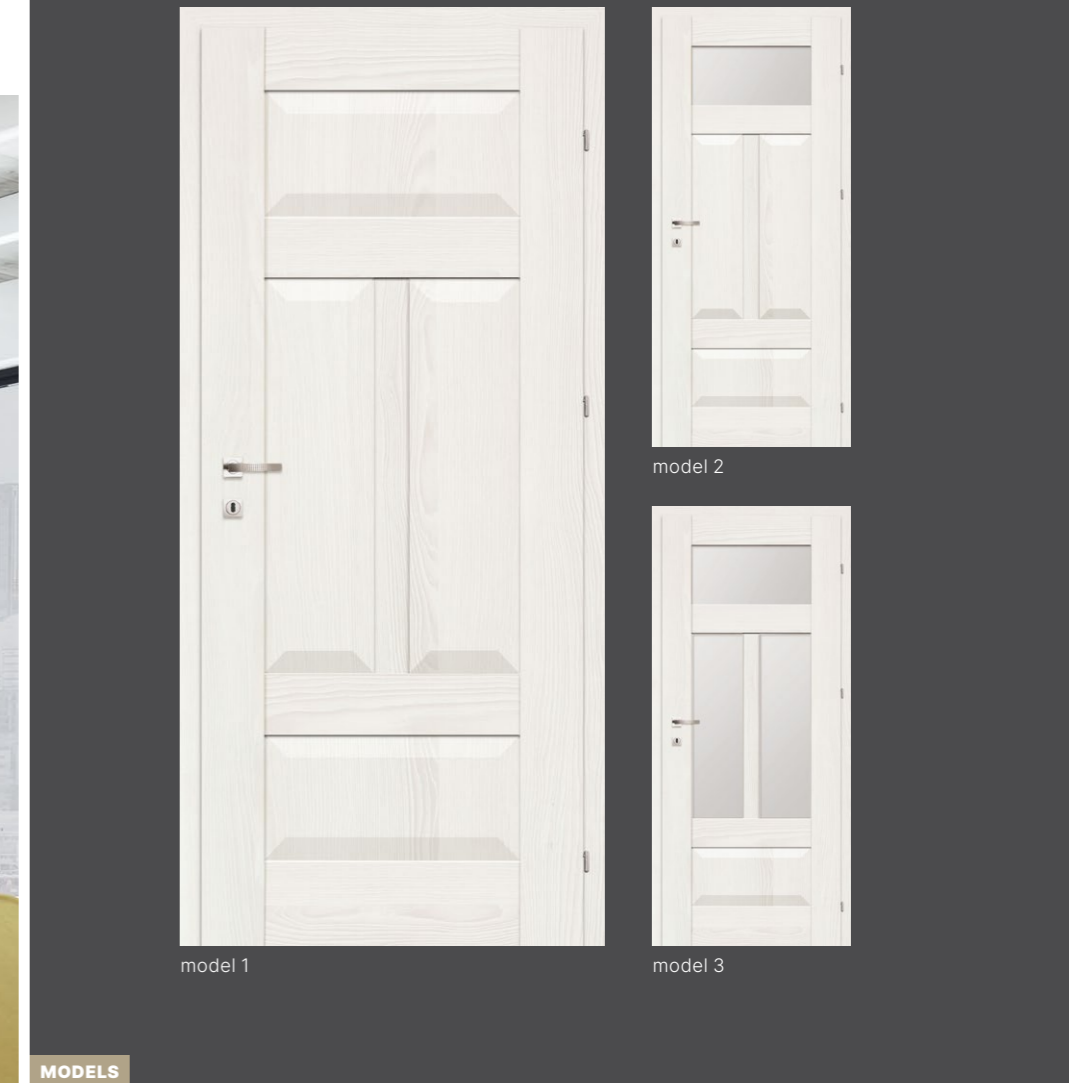

MODELS

DETAILS

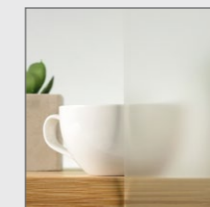

satin glass

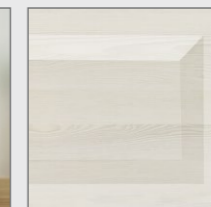

coffering profile

## DOOR SPECIFICATION

- frame elements made of MDF board
- satin glass, thickness 4 mm or coffering

### Rebated door leaf:

- three silver screw-in hinges
- lock: mortice key lock / bathroom lock / cylinder lock / passage lock

## DEDICATED DOOR FRAMES

### Hard edge K:

- fixed and adjustable door frames for rebated doors

## EXTRA-COST OPTIONS

### Ventilation:

- ventilation undercut
- ventilation undercut 15 mm (recuperation)

### Construction:

- door leaf 100'
- sliding and passive door leaf

## 3D LOOK



WHITE ASH



OILED OAK

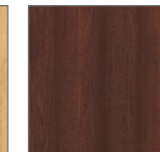

BURNT OAK

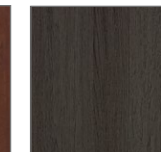

ANTHRACITE OAK

## 3D LOOK



GRAY OAK



CATANIA OAK

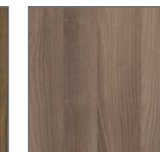

GRAPHITE ASH



NORWEGIAN ASH

## IRIDIUM

## CPL

# VENEER PANEL DOORS

Universal and thus guaranteeing versatile use. They are perfect for every room - from the kitchen and living room to the bathroom. Thanks to them it is possible to create a coherent design of the entire apartment or house. The veneers covering the door leaves are durable and scratch resistant. Their advantage is also the variety of designs that fit into current trends and beautifully imitate the wood texture. You can find there not only classic beige and brown, but also shades of white, gray or anthracite. This rich palette of decors allows you to easily adapt them to any style of arrangement.



A SCANDINAVIAN INTERIOR WITH A TOUCH OF BOHO. An interesting combination for those, who are looking for a way to break the simplicity of Scandinavian style. It is worth complementing the arrangement by using a door with white veneer, imitating wood texture.

CLASSIC DECOR DOESN'T HAVE TO BE BORING. Are you looking for timeless yet distinctive doors? Choose the door leaves with veneered surface. You can choose from many different colours. You will surely find the one that will create a coherent composition together with other elements of the decor.



# SAGA



model 1 / 1a / 1b    model 2 / 2a / 2b    model 3 / 3a / 3b    model 4 / 4a / 4b

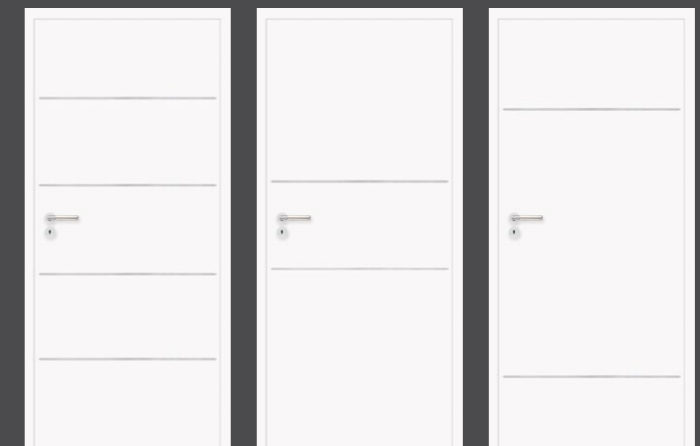

model 5 / 5a / 5b    model 6 / 6a / 6b    model 7 / 7a / 7b

**MODELS**

**DETAILS**

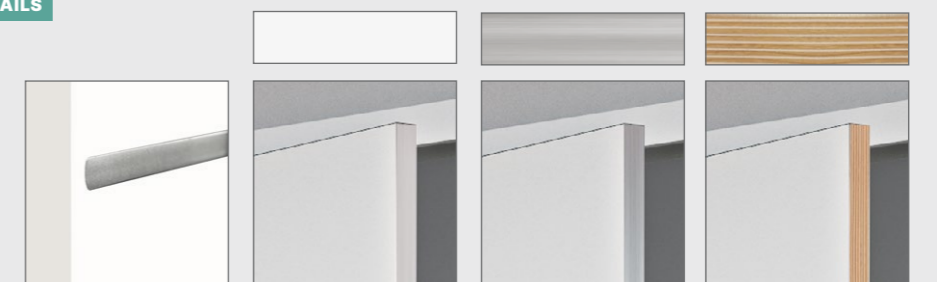

aluminum profile, 8 mm    rebate finish in white decor (models 1-7)    rebate finish in aluminum decor (models 1a-7a)    rebate finish in plywood decor (models 1b-7b)

**DOOR SPECIFICATION**

- peripheral frame made of softwood
- detail: aluminum profile, width: 8 mm, aligned with a door leaf surface

**Rebated door leaf:**

- three silver screw-in pintle hinges
- lock: mortice key lock / bathroom lock / cylinder lock / passage lock

**Non-rebated door leaf:**

- two openings for 3D hidden hinges
- magnetic lock: mortice key lock / bathroom lock / cylinder lock / passage lock

**DEDICATED DOOR FRAMES**

**Hard edge K:**

- fixed and adjustable door frames for rebated doors

**Hard edge B:**

- adjustable non-rebated door frame

**EXTRA-COST OPTIONS**

**Ventilation:**

- ventilation undercut
- ventilation undercut 15 mm (recuperation)
- ventilation sleeves – PVC

**Construction:**

- door leaf 100'
- non-rebated door leaf
- sliding and passive door leaf

**CPL**

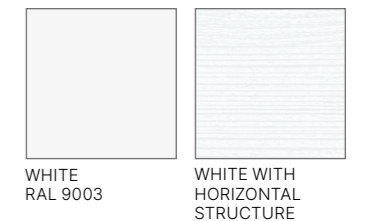

# ASTERIA NL

VENEER PANEL DOORS REBATED / NON-REBATED

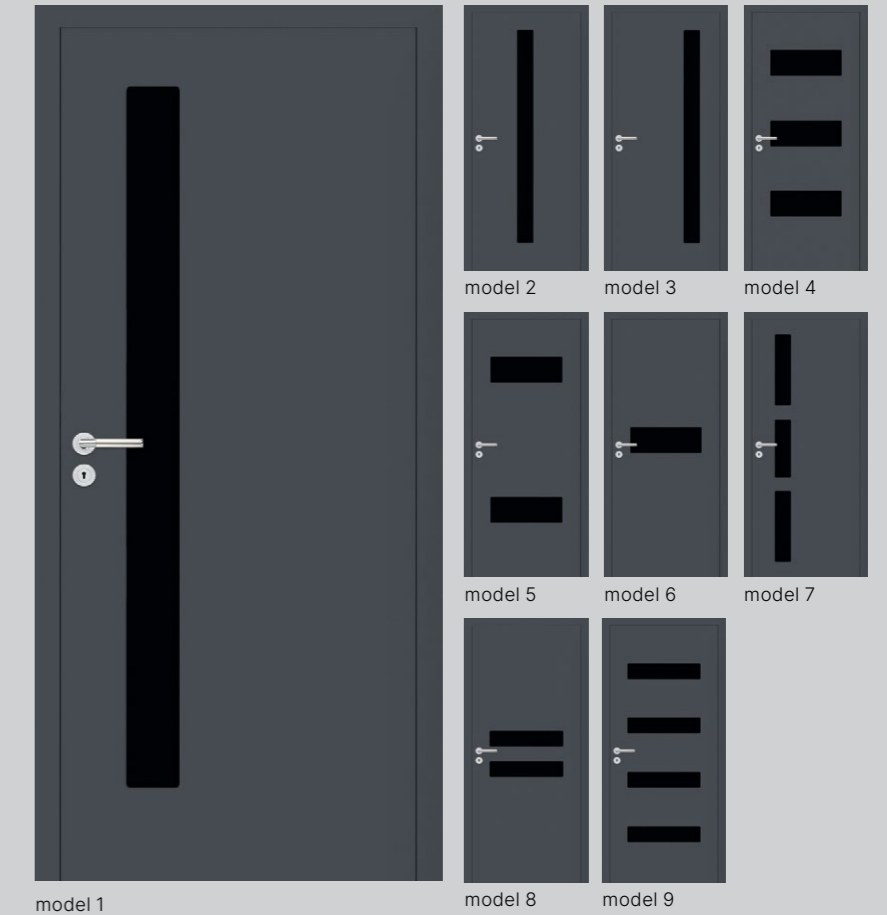

MODELS

DETAILS

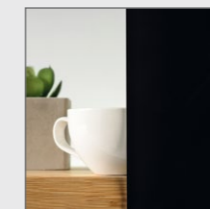

graphite painted glass, aligned with a door leaf surface

## DOOR SPECIFICATION

- peripheral frame made of softwood
- opaque graphite painted glass

### Rebated door leaf:

- three silver screw-in pintle hinges
- lock: mortice key lock / bathroom lock / cylinder lock / passage lock

### Non-rebated door leaf:

- two openings for 3D hidden hinges
- magnetic lock: mortice key lock / bathroom lock / cylinder lock / passage lock

## DEDICATED DOOR FRAMES

### Hard edge K:

- fixed and adjustable door frames for rebated doors

### Hard edge B:

- adjustable non-rebated door frame

## EXTRA-COST OPTIONS

### Ventilation:

- ventilation undercut
- ventilation undercut 15 mm (recuperation)
- ventilation sleeves – PVC
- ventilation sleeves – satin chrome steel

### Construction:

- door leaf 100'
- non-rebated door leaf
- sliding and passive door leaf

## IRIDIUM

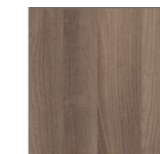

GRAPHITE ASH



SNOW ASH

## CPL

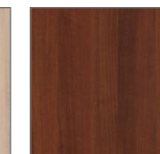

ITALIAN WALNUT



LIGHT ACACIA



NORWEGIAN ASH



GRIGIO OAK

## CPL



KENDAL OAK



WHITE RAL 9003



GRAY RAL 7047

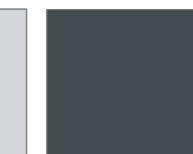

GRAPHITE RAL 7024

# ASTERIA

VENEER PANEL DOORS REBATED / NON-REBATED

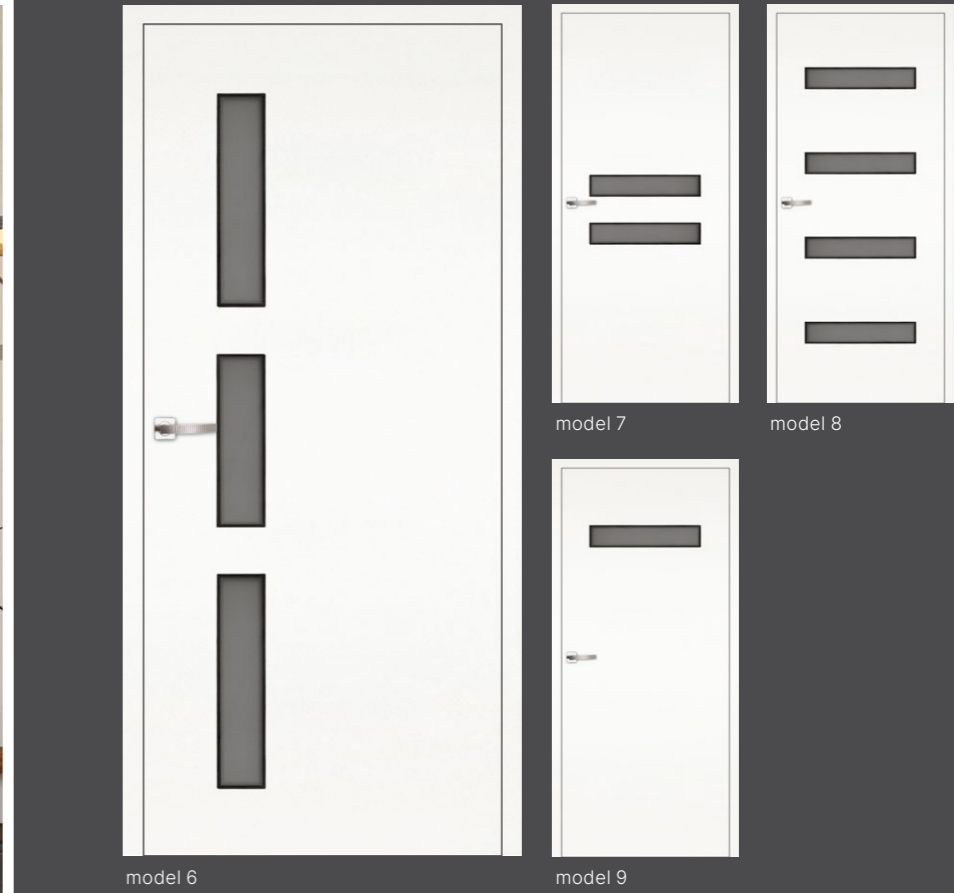

MODELS  
DETAILS



toughened safety transparent glass with an overprint (raster)  
 OPTION / graphite satin glass with an overprint (raster)  
 glass aligned with a door leaf surface

## DOOR SPECIFICATION

- peripheral frame made of softwood / MDF, HLT solid chipboard core
- Hard Edge R door leaf edge profile for Iridium decors
- Hard Edge PF door leaf edge profile for CPL decors
- toughened safety transparent glass with an overprint

### Rebated door leaf:

- three silver screw-in pintle hinges
- lock: mortice key lock / bathroom lock / cylinder lock / passage lock

### Non-rebated door leaf:

- two openings for 3D hidden hinges
- magnetic lock: mortice key lock / bathroom lock / cylinder lock / passage lock

### DEDICATED DOOR FRAMES

#### Hard edge R/PF:

- fixed and adjustable door frames for rebated doors

#### Hard edge B:

- adjustable non-rebated door frame

## EXTRA-COST OPTIONS

### Ventilation:

- ventilation undercut
- ventilation undercut 15 mm (recuperation)
- ventilation sleeves – satin chrome steel

### Glazing:

- safety glass, graphite satin with raster overprint \*

### Construction:

- door leaf 100'
- non-rebated door leaf
- sliding and passive door leaf

### IRIDIUM



### CPL\*\*

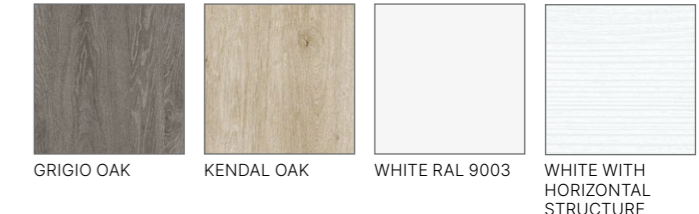

\* | Extended delivery time.

\*\* | Hard Edge PF door construction for CPL decors.

# DISCOVERY

VENEER PANEL DOORS REBATED / NON-REBATED

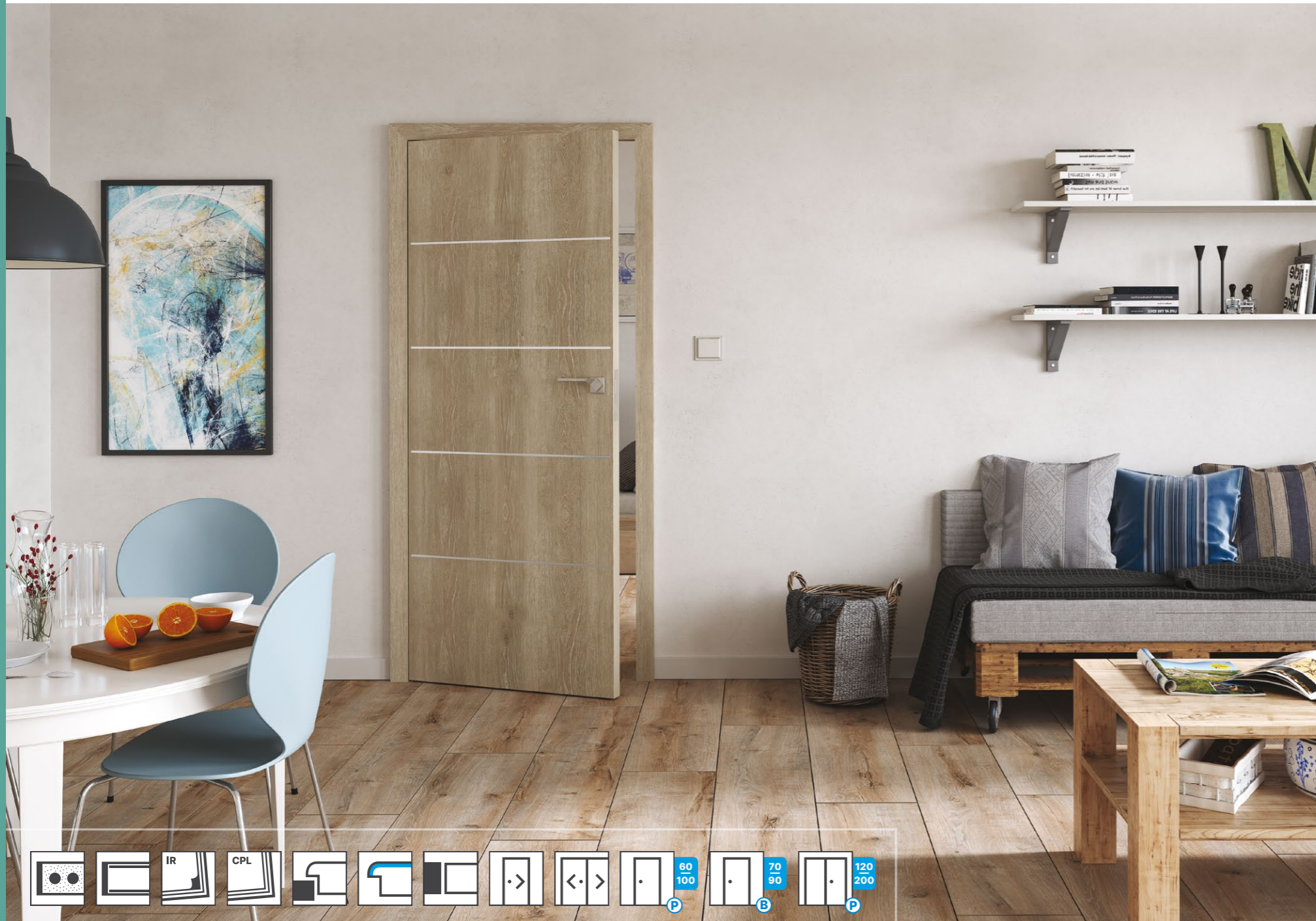

model 1      model 2      model 3      model 4



model 5      model 6      model 10      model 11

## MODELS

## DETAILS

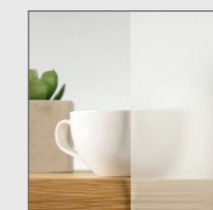

milky-white toughened transparent glass



glazing frame



aluminum profile 8mm

### DOOR SPECIFICATION

- Hard Edge R door leaf edge profile for Iridium decors, peripheral frame made of softwood \*
- Hard Edge PF door leaf edge profile for CPL decors, peripheral frame made of MDF board, reinforced \*
- detail: aluminum profile, width: 8 mm, aligned with a door leaf surface
- toughened safety transparent glass with an overprint

### Rebated door leaf:

- three silver screw-in pintle hinges
- lock: mortice key lock / bathroom lock / cylinder lock / passage lock

### Non-rebated door leaf:

- two openings for 3D hidden hinges
- magnetic lock: mortice key lock / bathroom lock / cylinder lock / passage lock

### EXTRA-COST OPTIONS

#### Ventilation:

- ventilation undercut
- ventilation undercut 15 mm (recuperation)
- ventilation sleeves – satin chrome steel

#### Construction:

- door leaf 100'
- non-rebated door leaf
- sliding and passive door leaf

\* | Perforated chipboard core (models 4–11), Classen Hard construction (models 1–3).

\*\* | Hard Edge PF door construction for CPL decors.

### IRIDIUM

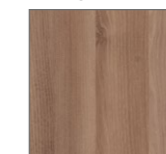

BROWN ASH

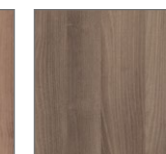

GRAPHITE ASH



SNOW ASH

### CPL\*\*

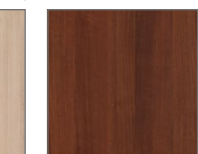

ITALIAN WALNUT



LIGHT ACACIA

### CPL\*\*



NORWEGIAN ASH



GRIGIO OAK



KENDAL OAK



WHITE RAL 9003



WHITE WITH HORIZONTAL STRUCTURE



# TETYDA

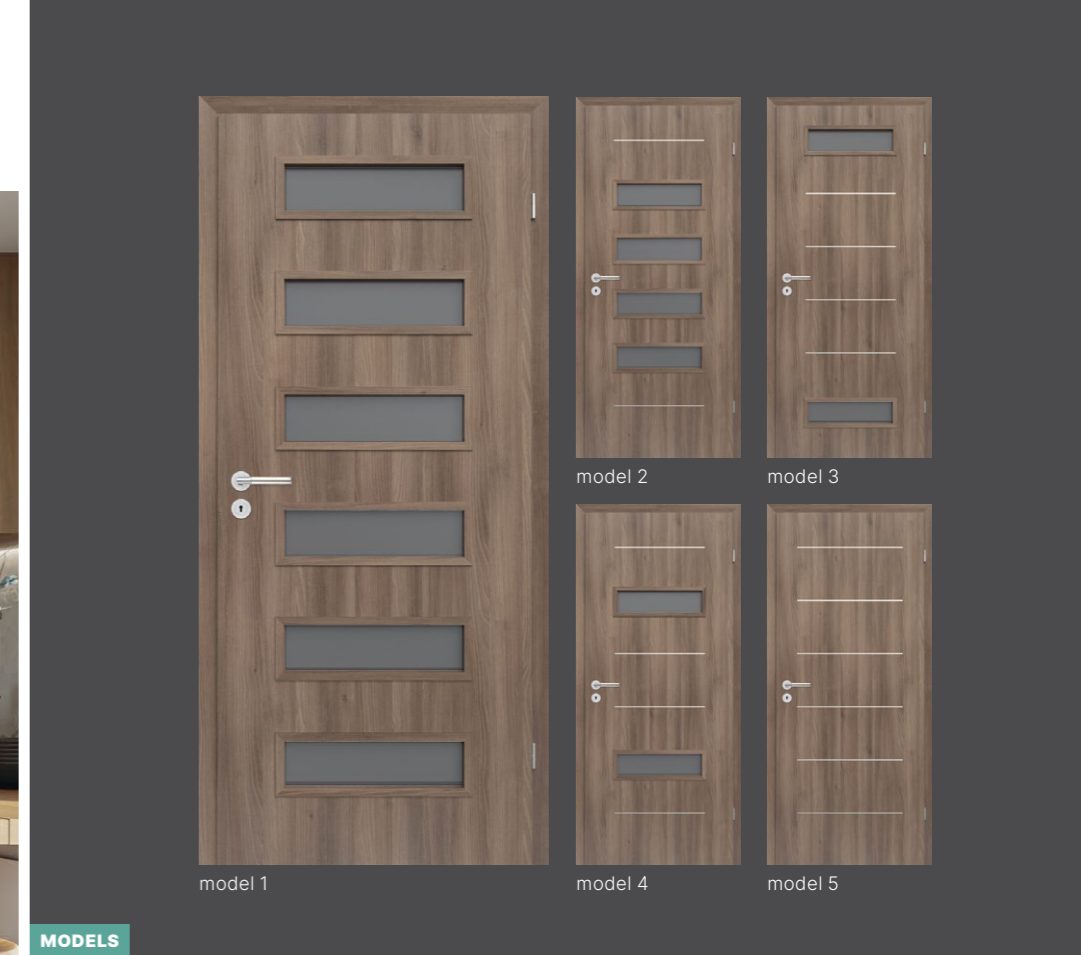

**MODELS**  
**DETAILS**

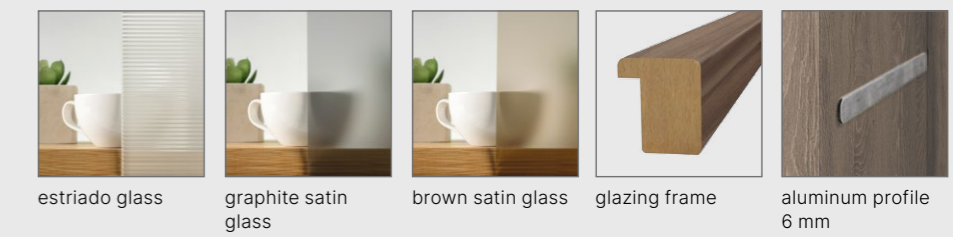

**DOOR SPECIFICATION**

- Hard Edge R door leaf edge profile for 3D Look and Iridium decors, Classen Hard construction / peripheral frame made of softwood
- Hard Edge PF door leaf edge profile for CPL decors, Classen Hard construction / peripheral frame made of MDF board, reinforced
- detail: aluminum profile, width: 6 mm
- safety toughened Estriado glass, brown satin, graphite satin

**Rebated door leaf:**

- two silver screw-in pintle hinges \*
- lock: mortice key lock / bathroom lock / cylinder lock / passage lock

**Non-rebated door leaf:**

- Classen Hard construction / peripheral frame made of softwood
- two openings for 3D hidden hinges
- magnetic lock: mortice key lock / bathroom lock / cylinder lock / passage lock

**DEDICATED DOOR FRAMES**

**Hard edge PF/R:**

- fixed and adjustable door frames for rebated doors

**Hard edge B:**

- adjustable non-rebated door frame

**EXTRA-COST OPTIONS**

**Ventilation:**

- ventilation undercut
- ventilation undercut 15 mm (recuperation)
- ventilation sleeves – PVC

**Construction:**

- door leaf 100'
- third hinge
- reinforced with perforated chipboard \*\*
- non-rebated door leaf
- sliding and passive door leaf

\* | Door leaves 100' and reinforced door leaves regardless of the size – the set includes 3 hinges.  
 \*\* | No Hard reinforcement.  
 \*\*\* | Non-rebated model is not available in marked decors.  
 \*\*\*\* | Hard Edge PF door construction for CPL decors.

**3D LOOK \*\*\***



**IRIDIUM**



**CPL \*\*\*\***

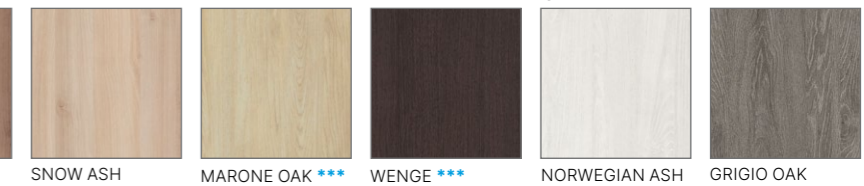

**CPL \*\*\*\***



# NATURA HR

VENEER PANEL DOORS REBATED

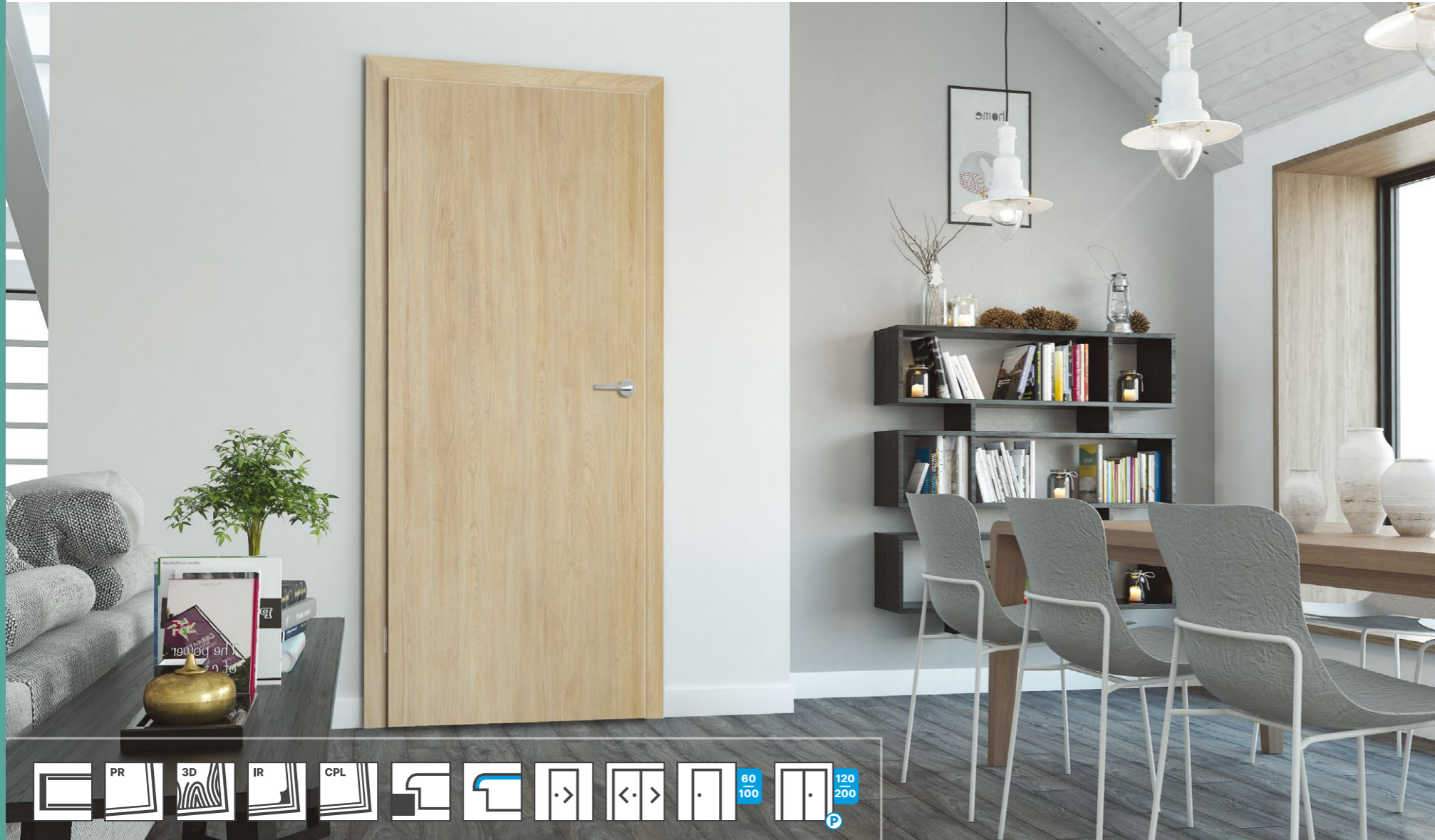

Door leaf with porthole is not available in sliding version, more on page 144.

MODELS

DETAILS

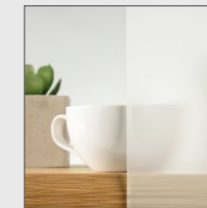

milky-white toughened transparent glass



glazing frame profile

## DOOR SPECIFICATION

### Rebated door leaf:

- Hard Edge R door leaf edge profile for Primo, 3D Look and Iridium decors, Classen Hard construction / peripheral frame made of softwood
- Hard Edge PF door leaf edge profile for CPL decors, peripheral frame made of MDF board, reinforced,
- Classen Hard construction
- two silver screw-in pintle hinges \*
- lock: mortice key lock / bathroom lock / cylinder lock / passage lock
- milky-white toughened safety glass

## DEDICATED DOOR FRAMES

### Hard edge R/PF:

- fixed and adjustable door frames for rebated doors

## EXTRA-COST OPTIONS

### Ventilation:

- ventilation undercut
- ventilation undercut 15 mm (recuperation)
- PVC ventilation sleeves

### Glazing:

- porthole 35 ml (model 1)
- transparent glass (models 2-4)

### Construction:

- third hinge
- perforated chipboard \*\*
- solid chipboard \*\*
- door leaf 100'
- sliding and passive door leaf

## PRIMO



ACACIA ST BEECH NATURAL OAK WALNUT

## 3D LOOK



SONOMA OAK RIVIERA OAK WHITE ASH COLOMBIA LIGHT WALNUT

## 3D LOOK



OILED OAK BURNT OAK GRAY OAK CATANIA OAK

## IRIDIUM



GRAPHITE ASH BROWN ASH SNOW ASH MARONE OAK

## IRIDIUM



WENGE

## CPL \*\*\*

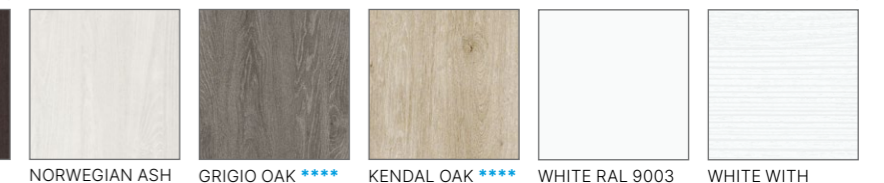

NORWEGIAN ASH GRIGIO OAK \*\*\*\* KENDAL OAK \*\*\*\* WHITE RAL 9003 WHITE WITH HORIZONTAL STRUCTURE

\* | Door leaves 100' and reinforced door leaves regardless of the size – the set includes 3 hinges.

\*\* | No Hard reinforcement.

\*\*\* | Hard Edge PF door construction for CPL decors.

\*\*\*\* | Decor available only for model 1.

# ANDROMEDA

VENEER PANEL DOORS REBATED / NON-REBATED



## MODELS

## DETAILS

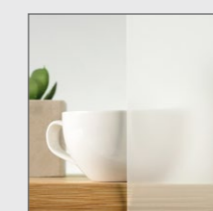

milky-white toughened safety glass

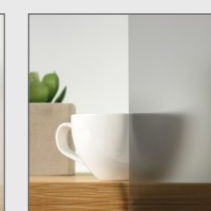

OPTION / graphite satin glass

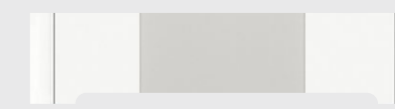

ventilation undercut available for all models

### DOOR SPECIFICATION

- peripheral frame made of softwood
- milky-white toughened safety glass

#### Rebated door leaf:

- three silver screw-in pintle hinges
- lock: mortice key lock / bathroom lock / cylinder lock / passage lock

#### Non-rebated door leaf:

- two openings for 3D hidden hinges
- magnetic lock: mortice key lock / bathroom lock / cylinder lock / passage lock

### DEDICATED DOOR FRAMES

#### Hard edge R:

- fixed and adjustable door frames for rebated doors

#### Hard edge B:

- adjustable non-rebated door frame

### EXTRA-COST OPTIONS

#### Ventilation:

- ventilation undercut

#### Glazing:

- safety glass, graphite satin

#### Construction:

- door leaf 100'
- non-rebated door leaf

### IRIDIUM

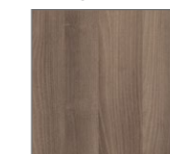

GRAPHITE ASH

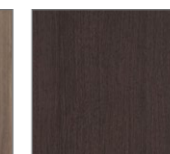

WENGE

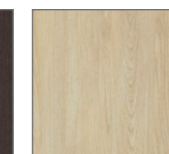

MARONE OAK \*

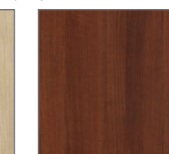

ITALIAN WALNUT



LIGHT ACACIA

### CPL



NORWEGIAN ASH



GRIGIO OAK



KENDAL OAK



WHITE RAL 9003



WHITE WITH HORIZONTAL STRUCTURE

\* | Decor in not available in non-rebated model.

# DEMETER

VENEER PANEL DOORS REBATED



MODELS

DETAILS

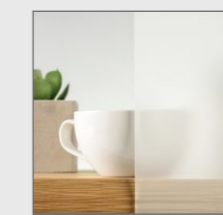

milky-white toughened transparent glass



glazing frame

## DOOR SPECIFICATION

- Hard Edge R door leaf edge profile for Primo, 3D Look and Iridium decors, Classen Hard construction / peripheral frame made of softwood
- Hard Edge PF door leaf edge profile for CPL decors, Classen Hard construction / peripheral frame made of MDF board, reinforced
- milky-white toughened safety glass

### Rebated door leaf:

- two silver screw-in pintle hinges \*
- lock: mortice key lock / bathroom lock / cylinder lock / passage lock
- **NOTE** – single leaf
  - 60–100' (models 1 and 4)
  - 70–100' (models 2, 3, 5)

## DEDICATED DOOR FRAMES

### Hard edge PF/R:

- fixed and adjustable door frames for rebated doors

## EXTRA-COST OPTIONS

### Ventilation:

- ventilation undercut
- ventilation undercut 15 mm (recuperation)
- PVC ventilation sleeves

### Construction:

- door leaf 100'
- third hinge
- reinforced with perforated chipboard \*\*
- sliding and passive door leaf

## PRIMO



ACACIA ST   NATURAL OAK   WALNUT

## 3D LOOK



SONOMA OAK   RIVIERA OAK   COLOMBIA LIGHT WALNUT   WHITE ASH   OILED OAK

## 3D LOOK

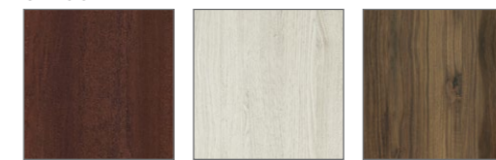

BURNT OAK   GRAY OAK   CATANIA OAK

## IRIDIUM

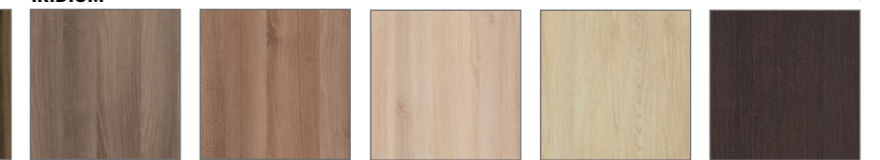

GRAPHITE ASH   BROWN ASH   SNOW ASH   MARONE OAK   WENGE

## IRIDIUM



GRAY MATT

## CPL \*\*\*



NORWEGIAN ASH   GRIGIO OAK   KENDAL OAK   ITALIAN WALNUT   LIGHT ACACIA

\* | Door leaves 100' and reinforced door leaves regardless of the size – the set includes 3 hinges.

\*\* | No Hard reinforcement.

\*\*\* | Hard Edge PF door construction for CPL decors.

# ARENA

VENEER PANEL DOORS REBATED

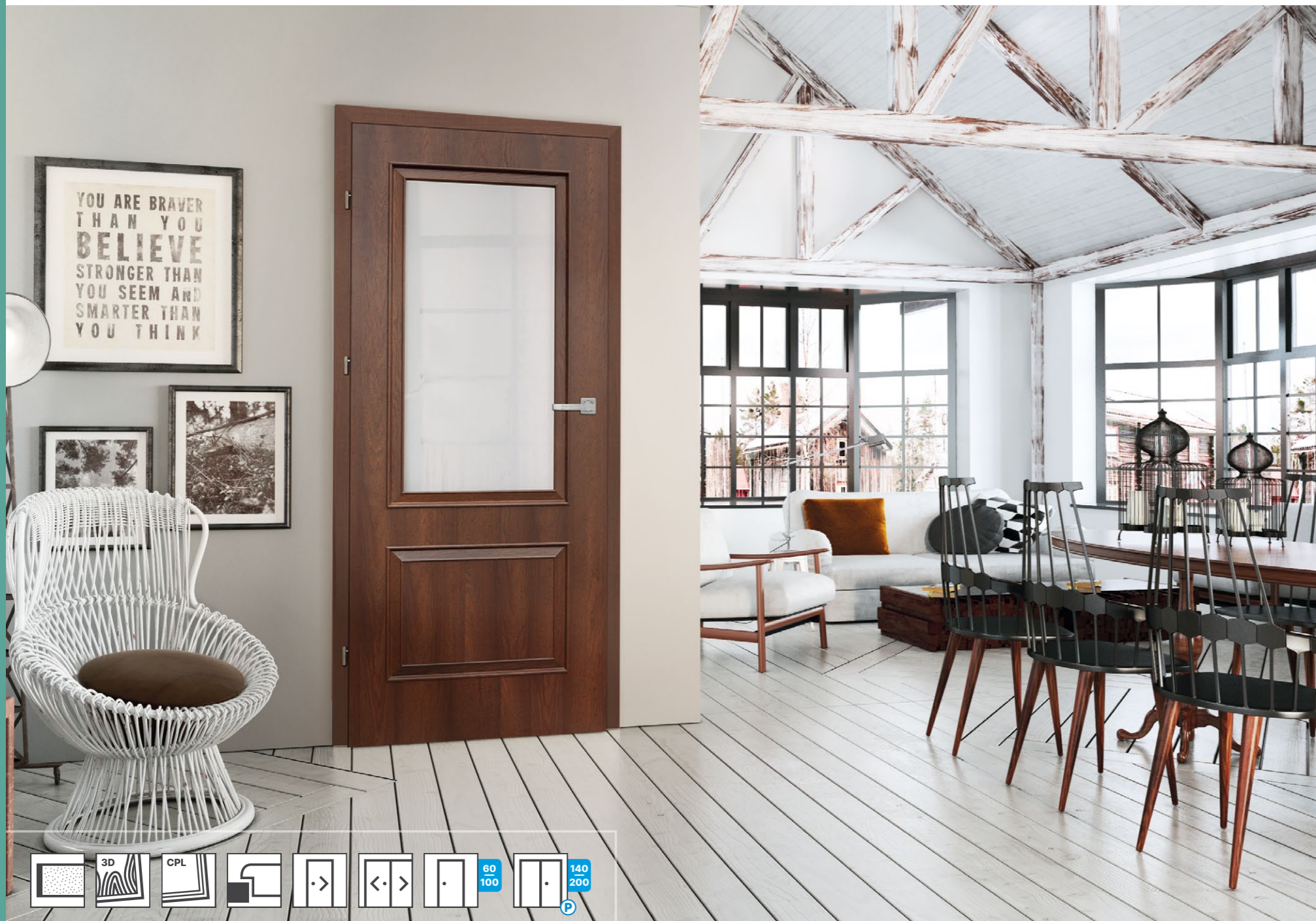

model 1      model 2      model 3      model 4 \*



model 5      model 6      model 7

MODELS

DETAILS



satin glass      OPTION / brown satin glass      OPTION / graphite satin glass      glazing frame

**DOOR SPECIFICATION**

- peripheral frame made of softwood
- satin glass
- Rebated door leaf:**
- three silver screw-in pintle hinges
- lock: mortice key lock / bathroom lock / cylinder lock / passage lock

**DEDICATED DOOR FRAMES**

- Hard edge R:**
- fixed and adjustable door frames for rebated doors

**EXTRA-COST OPTIONS**

- Ventilation:**
- ventilation undercut
- ventilation undercut 15 mm (recuperation)
- PVC ventilation sleeves
- Glazing:**
- satin glass, brown or graphite \*\*
- Construction:**
- door leaf 100'
- sliding and passive door leaf

**3D LOOK**

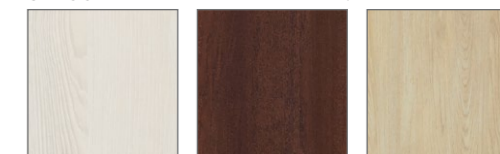

WHITE ASH      BURNT OAK      MARONE OAK

**IRIDIUM**

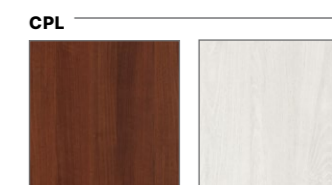

ITALIAN WALNUT      NORWEGIAN ASH

**CPL**

\* | For model 4 Classen Hard construction.

\*\* | Extended delivery time.

# CENTURY

VENEER PANEL DOORS REBATED

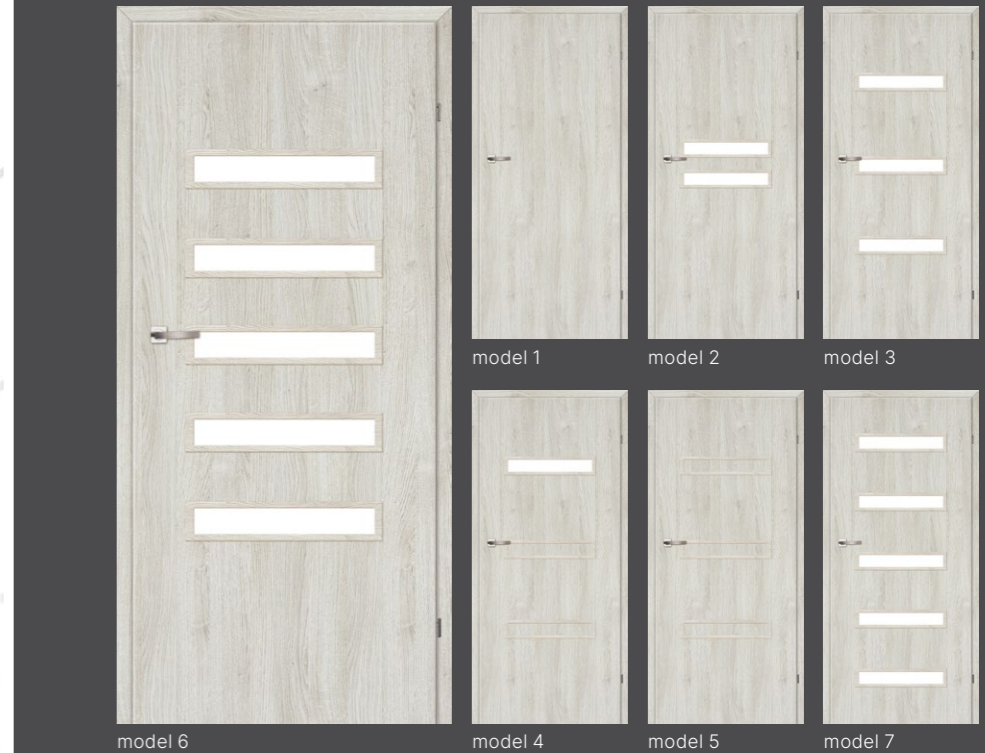

**MODELS**

**DETAILS**

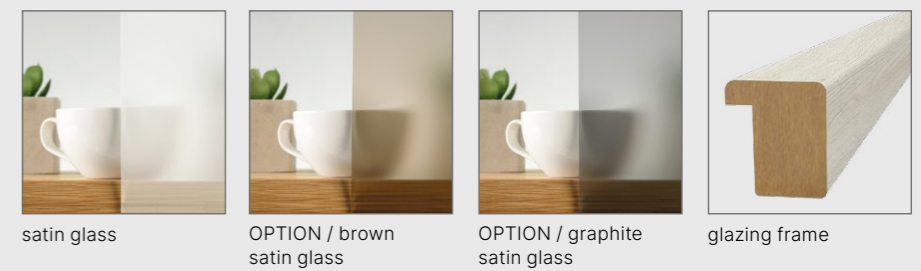

**DOOR SPECIFICATION**

- peripheral frame made of MDF board
- satin glass

**Rebated door leaf:**

- two silver screw-in pintle hinges \*
- lock: mortice key lock / bathroom lock / cylinder lock / passage lock

**DEDICATED DOOR FRAMES**

**Hard edge R:**

- fixed and adjustable door frames for rebated doors

**EXTRA-COST OPTIONS**

**Ventilation:**

- ventilation undercut
- ventilation undercut 15 mm (recuperation)
- PVC ventilation sleeves

**Glazing:**

- satin glass, brown or graphite \*\*

**Construction:**

- door leaf 100'
- sliding and passive door leaf \*\*\*

**PRIMO**



**3D LOOK**



**3D LOOK**



**IRIDIUM**

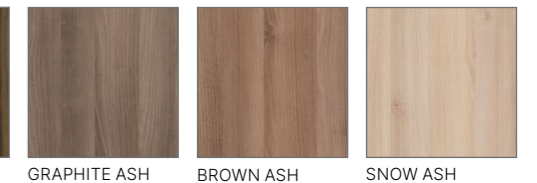

**IRIDIUM**



**CPL**



\* | Door leaves 100' and reinforced door leaves regardless of the size – 3 hinges.

\*\* | Extended delivery time.

\*\*\* | Passive doors are produced using peripheral frame made of softwood.

# MALAGA

VENEER PANEL DOORS REBATED



MODELS  
DETAILS

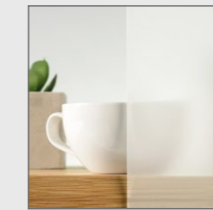

milky-white toughened safety glass

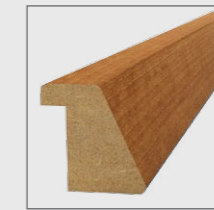

glazing frame

## DOOR SPECIFICATION

- peripheral frame made of MDF board
- milky-white toughened safety glass

### Rebated door leaf:

- two silver screw-in pintle hinges \*
- lock: mortice key lock / bathroom lock / cylinder lock / passage lock

## DEDICATED DOOR FRAMES

### Hard edge K:

- fixed and adjustable door frames for rebated doors

## EXTRA-COST OPTIONS

### Ventilation:

- ventilation grille
- PVC ventilation sleeves

### Construction:

- door leaf 100'
- third hinge
- reinforced with perforated chipboard \*\*
- sliding and passive door leaf \*\*

## PRIMO



## 3D LOOK

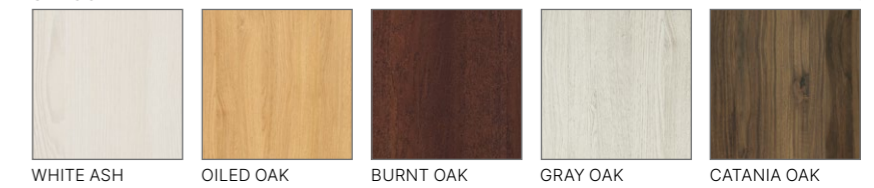

## IRIDIUM



\* | Door leaves 100' and reinforced door leaves regardless of the size – 3 hinges.

\*\* | Doors reinforced with perforated chipboard and passive doors are produced using peripheral frame made of softwood.

# MODENA 4

VENEER PANEL DOORS REBATED



MODELS

DETAILS

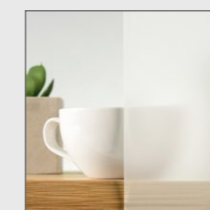

milky-white toughened safety glass



glazing frame

## DOOR SPECIFICATION

- peripheral frame made of MDF board
- milky-white toughened safety glass

### Rebated door leaf:

- two silver screw-in pintle hinges \*
- lock: mortice key lock / bathroom lock / cylinder lock / passage lock

## DEDICATED DOOR FRAMES

### Hard edge K:

- fixed and adjustable door frames for rebated doors

## EXTRA-COST OPTIONS

### Ventilation:

- ventilation grille
- PVC ventilation sleeves

### Construction:

- door leaf 100'
- third hinge
- reinforced with perforated chipboard \*\*
- sliding and passive door leaf \*\*

## PRIMO

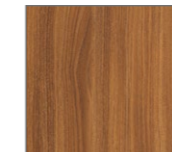

ACACIA ST

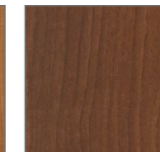

WALNUT



WHITE

## 3D LOOK



RIVIERA OAK



COLOMBIA LIGHT WALNUT



WHITE ASH

## 3D LOOK



GRAY OAK



CATANIA OAK

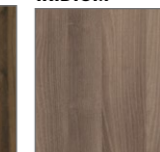

GRAPHITE ASH

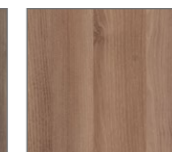

BROWN ASH

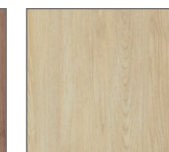

MARONE OAK

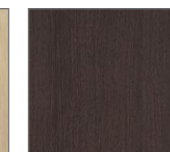

WENGE

\* | Door leaves 100' and reinforced door leaves regardless of the size – 3 hinges.

\*\* | Doors reinforced with perforated chipboard and passive doors are produced using peripheral frame made of softwood.



# NATURA

VENEER PANEL DOORS REBATED



**MODELS**

**DETAILS**



**DOOR SPECIFICATION**

- peripheral frame made of MDF board
- ornamental glass, transparent bark

**Rebated door leaf:**

- two silver screw-in pintle hinges \*
- lock: mortice key lock / bathroom lock / cylinder lock / passage lock

**DEDICATED DOOR FRAMES**

**Hard edge K:**

- fixed and adjustable door frames for rebated doors

**EXTRA-COST OPTIONS**

**Ventilation:**

- ventilation grille
- PVC ventilation sleeves

**Construction:**

- door leaf 100'
- third hinge
- reinforced with perforated chipboard \*\*\*
- sliding and passive door leaf \*\*\*

**PRIMO**



**3D LOOK**



**3D LOOK**

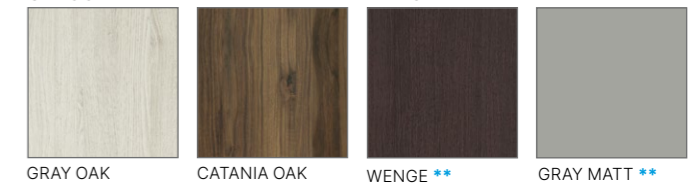

**IRIDIUM**

\* | Door leaves 100' and reinforced door leaves regardless of the size – 3 hinges.

\*\* | Decor available only for full model.

\*\*\* | Doors reinforced with perforated chipboard and passive doors are produced using peripheral frame made of softwood.

# ANTIOPE

VENEER PANEL DOORS REBATED



MODELS

DETAILS

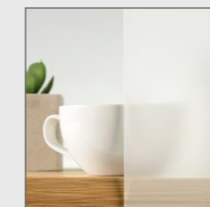

milky-white toughened safety glass



glazing frame

## DOOR SPECIFICATION

- peripheral frame made of MDF board
- milky-white toughened safety glass

### Rebated door leaf:

- two silver screw-in pintle hinges \*
- lock: mortice key lock / bathroom lock / cylinder lock / passage lock

## DEDICATED DOOR FRAMES

### Hard edge R:

- fixed and adjustable door frames for rebated doors

## EXTRA-COST OPTIONS

### Ventilation:

- ventilation grille
- PVC ventilation sleeves

### Construction:

- door leaf 100'
- third hinge
- sliding and passive door leaf

## PRIMO

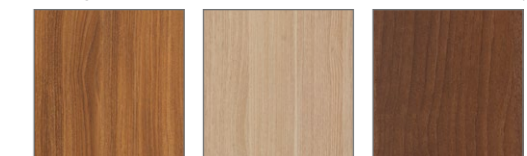

ACACIA ST

NATURAL OAK

WALNUT

## 3D LOOK

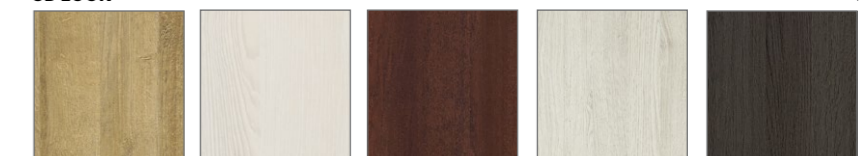

RIVIERA OAK

WHITE ASH

BURNT OAK

GRAY OAK

ANTHRACITE OAK

\* | Door leaves 100' and reinforced door leaves regardless of the size – 3 hinges.

# TEMIDA

VENEER PANEL DOORS REBATED



## MODELS

## DETAILS



3/3 glass

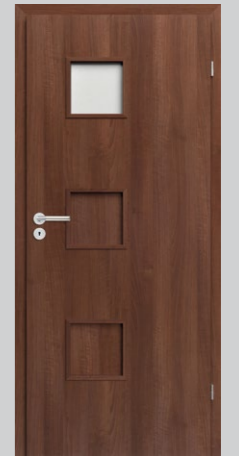

1/3 glass

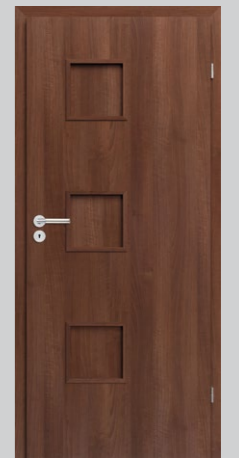

full

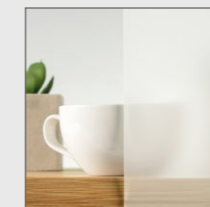

satin glass



glazing frame

### DOOR SPECIFICATION

- stabilizing honeycomb insert / peripheral frame made of MDF
- satin glass

### Rebated door leaf:

- two silver screw-in pintle hinges \*
- lock: mortice key lock / bathroom lock / cylinder lock / passage lock

### DEDICATED DOOR FRAMES

#### Hard edge R:

- fixed and adjustable door frames for rebated doors

### EXTRA-COST OPTIONS

#### Ventilation:

- PVC ventilation sleeves

#### Construction:

- door leaf 100'
- third hinge
- sliding and passive door leaf

### PRIMO

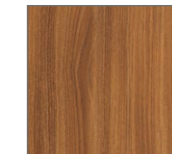

ACACIA ST

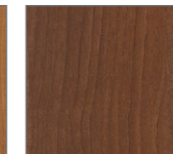

WALNUT

### 3D LOOK

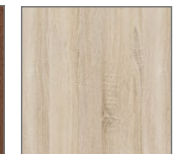

SONOMA OAK

\* | Door leaves 100' and reinforced door leaves regardless of the size – 3 hinges.

# SIDE PANEL

PASSIVE DOOR LEAF



A passive door leaf, commonly known as a "side panel", is used to widen the clear opening in places where there is no need or physical possibility to install full width double leaf doors.

The active leaf is used on a daily basis, while the passive leaf remains closed. If necessary, the passive part can be quickly opened and a wider door opening can be used.

It is a very simple and useful solution that increases the functionality of your door.

## DOOR SPECIFICATION

- veneer passive door leaf
- construction: peripheral frame made of MDF board
- two or three silver hinges
- adjustable strike plate and shootbolt
- available only as full version without glazing

## EXTRA-COST OPTIONS

- Construction:**
- third hinge
  - reinforced with perforated chipboard
  - falling threshold

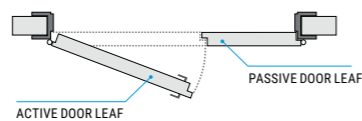

Find a door

PERFECTLY

tailored to your needs  
on our website.

[www.classen.pl](http://www.classen.pl)

# TECHNICAL PANEL DOORS

These are the doors for special tasks, and their high quality is confirmed by numerous certificates and approvals. Depending on the selected collection, they will perform different functions accordingly: they will ensure good sound insulation, fire protection or will constitute an additional protection against burglary. Moreover, their high functionality goes hand in hand with aesthetics – hence it is the ideal solution for public utility buildings, offices, hotels and restaurants.

**FUNCTIONALITY  
OR APPEARANCE?**  
You do not have to choose. No more compromises. Our technical doors have it all – excellent functional qualities and aesthetically pleasing design.

**FOR OFFICES,  
HOTELS AND  
RESTAURANTS.**  
Wherever high quality, good technical parameters and solid workmanship are important.



# NATURA HK CPL / HB CPL

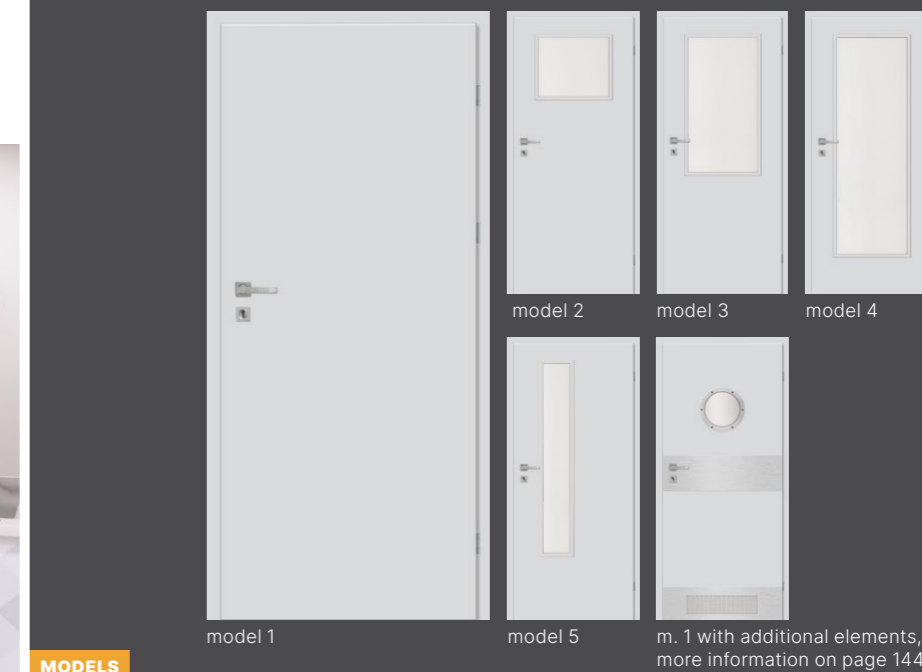

**MODELS**  
**DETAILS**



milky-white toughened safety glass  
glazing frame

## DOOR SPECIFICATION

- Classen Hard construction (does not apply to PN22 and PN23 versions)
- wide peripheral frame for PN22 and PN23 versions
- milky-white toughened safety glass
- possibility of shortening the leaf by 40 mm

### Rebated door leaf (HK):

- two silver screwed pintle hinges\*
- mortice key lock, bathroom lock, cylinder lock, passage lock

### Non-rebated door leaf (HB):

- two openings for hinges for non-rebated door
- magnetic lock: mortice key lock / bathroom lock / cylinder lock / passage lock

## DEDICATED DOOR FRAMES

### HK:

- steel adjustable door frame
- steel fixed door frame
- Standard 2 pack fixed door frame
- adjustable door frame

### HB:

- osteel fixed non-rebated door frame
- steel adjustable non-rebated door frame

## EXTRA-COST OPTIONS

### Ventilation:

- ventilation undercut
- ventilation undercut 15 mm (recuperation)
- PVC ventilation grille
- ventilation grille, aluminum
- steel kick-plate with ventilation grille

## EXTRA-COST OPTIONS

### Glazing:

- porthole 35 tr – transparent glass
- porthole 35 ml – milky-white glass
- transparent glass for the following models: 2, 3, 4, 5

### Construction:

- third hinge
- perforated chipboard\*\*
- solid chipboard\*\*\*
- non-rebated door leaf (HB)
- door leaf 100', 110', 120'
- door leaf model PN22
- door leaf model PN23
- sliding and passive door leaf

### Accessories:

- solid steel push-plate – one-sided
- solid steel push-plate – two-sided
- solid steel kick-plate – one-sided
- solid steel kick-plate – two-sided
- falling threshold

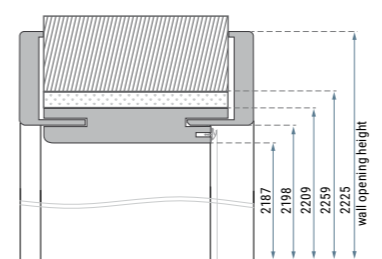

Dimensions of door frame for PN22 door.

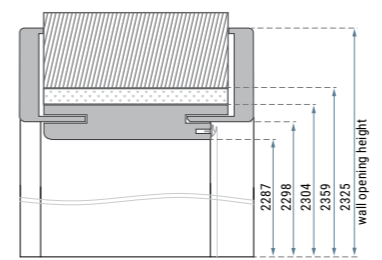

Dimensions of door frame for PN23 door.

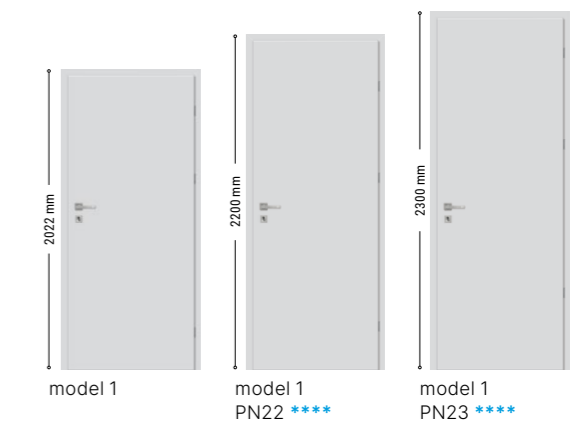

\* | Door leaves 100' and reinforced door leaves regardless of the size – 3 hinges.  
 \*\* | Maximum leaf width 110, without Hard reinforcement.  
 \*\*\* | Maximum leaf width 100, without Hard reinforcement.  
 \*\*\*\* | Models PN22 and PN23 available only as 1-leaf, width 60'-100'. They are not available in a non-rebated version and are not available with the following frames: Adjustable 80, Standard 2-pack fixed and steel door frame.

# NATURA HK HPL / HB HPL

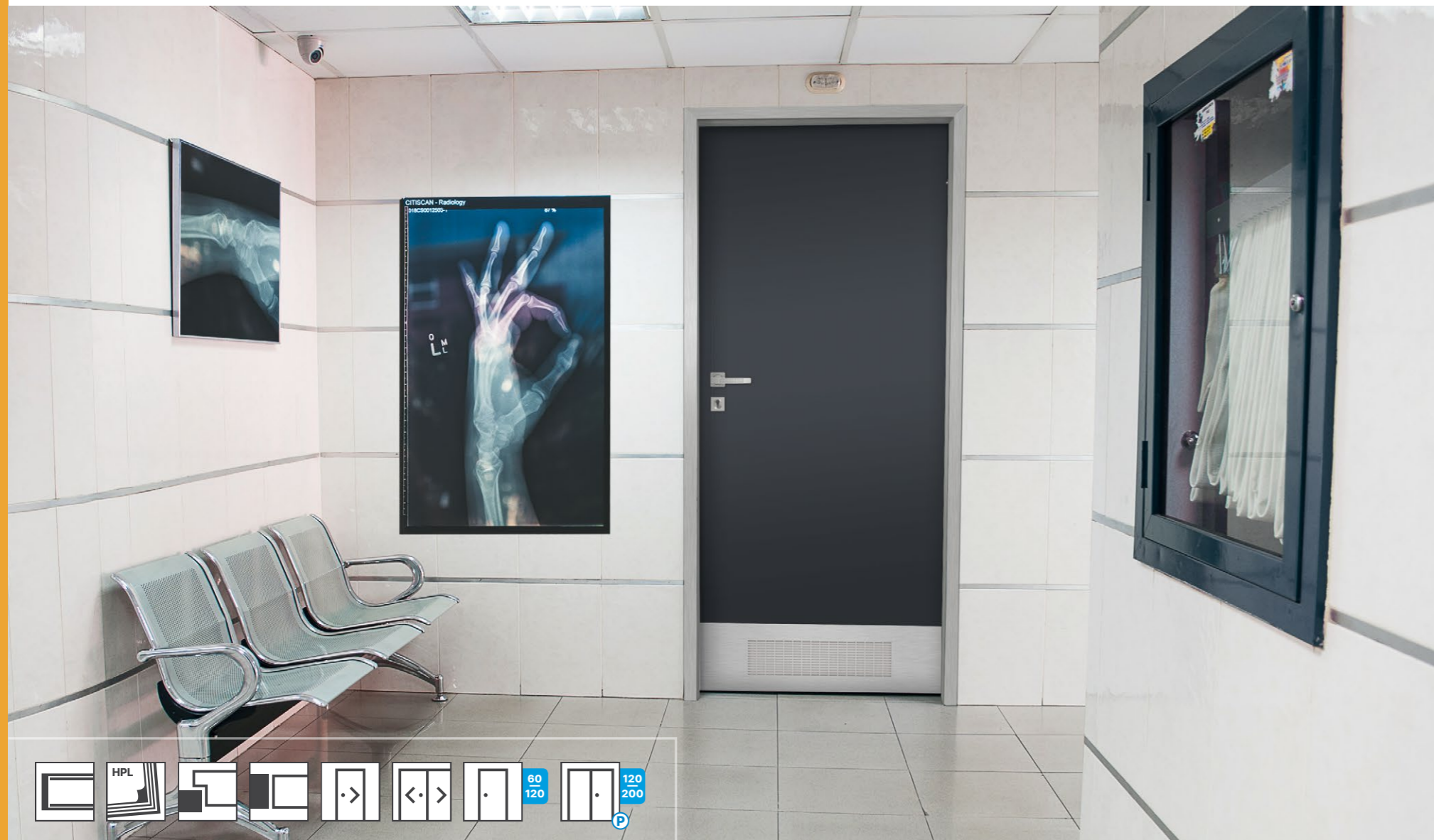

MODELS

DETAILS

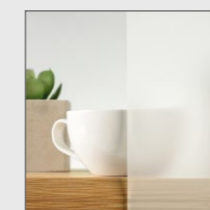
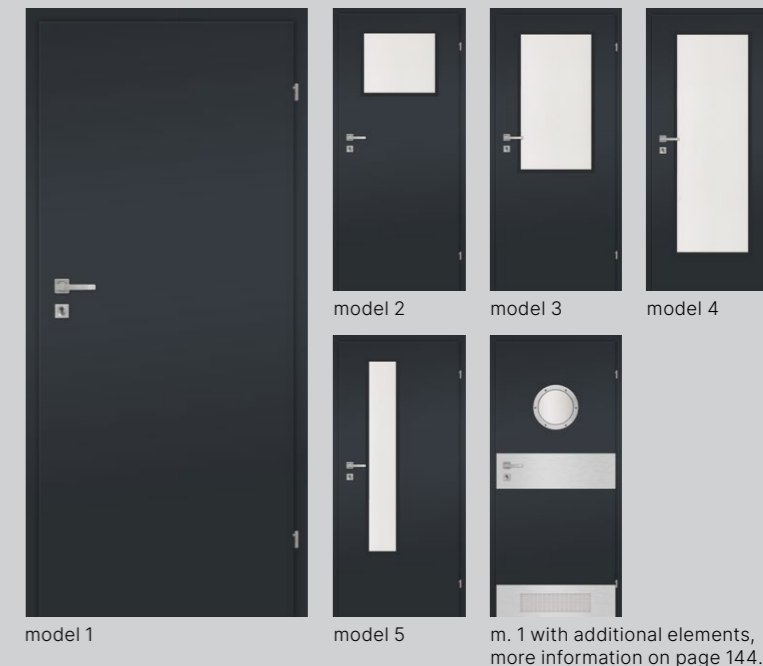

milky-white toughened safety glass



glazing frame

**DOOR SPECIFICATION**

- Classen Hard construction
- milky-white toughened safety glass
- possibility of shortening the leaf by 40 mm

**Rebated door leaf (HK):**

- two silver screw-in pintle hinges \*
- lock: mortice key lock / bathroom lock / cylinder lock / passage lock

**Non-rebated door leaf (HB):**

- two openings for hinges for non-rebated door
- magnetic lock: mortice key lock / bathroom lock / cylinder lock / passage lock

**DEDICATED DOOR FRAMES**

**HK:**

- steel adjustable door frame
- steel fixed door frame

**HB:**

- adjustable non-rebated door frame
- steel fixed non-rebated door frame
- steel adjustable non-rebated door frame

**EXTRA-COST OPTIONS**

**Ventilation:**

- ventilation undercut
- ventilation undercut 15 mm (recuperation)
- PVC ventilation grille
- ventilation grille, aluminum
- steel kick-plate with ventilation grille

**Glazing:**

- porthole 35 tr – transparent glass
- porthole 35 ml – milky-white glass
- transparent glass for the following models: 2, 3, 4, 5

**EXTRA-COST OPTIONS**

**Construction:**

- third hinge
- perforated chipboard \*\*
- solid chipboard \*\*
- non-rebated door leaf (HB)
- door leaf 100', 110', 120'
- sliding and passive door leaf

**Accessories:**

- solid steel push-plate – one-sided
- solid steel push-plate – two-sided
- solid steel kick-plate – one-sided
- solid steel kick-plate – two-sided
- falling threshold

**ADDITIONAL INFORMATION**

- other HPL decors (page 158) available upon individual enquiries: [inwestycje@classen.com.pl](mailto:inwestycje@classen.com.pl)
- decors not included in the standard offer are available with a rebate in brushed aluminum colour

\* | Door leaves 100' and reinforced door leaves regardless of the size – a 3 hinges.

\*\* | Maximum leaf width 110, without Hard reinforcement.

\*\*\* | Maximum leaf width 100, without Hard reinforcement.

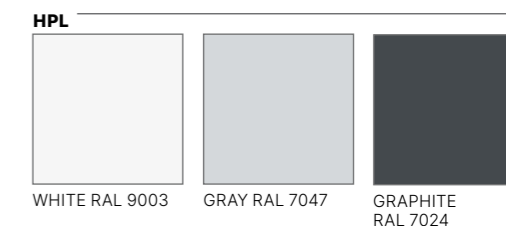

# GUARD

TECHNICAL PANEL DOORS REBATED



MODELS  
DETAILS

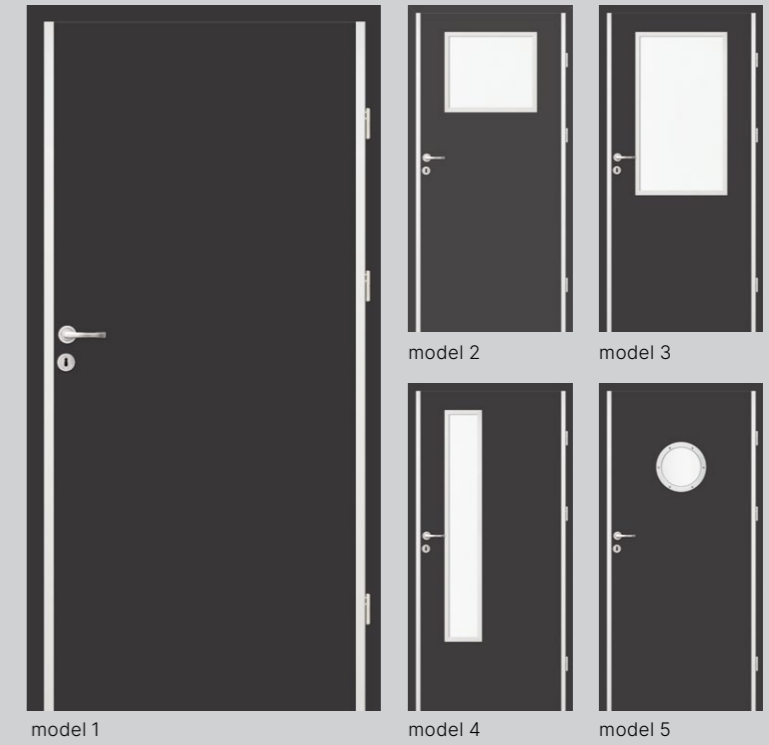

## DOOR SPECIFICATION

- reinforced construction plus, door leaf thickness – 40 mm
- door leaf edge protected with stainless steel kick-plate
- glazing frame made of stainless steel
- milky-white toughened safety glass, thickness: 4 mm
- three reinforced three-wing silver hinges
- cylinder lock
- reinforcement for door closer
- doors sold as a set with door frame

## DEDICATED DOOR FRAMES

- Hard edge K:**
- Guard steel fixed and adjustable door frame

## EXTRA-COST OPTIONS

- Ventilation:**
- PVC ventilation grille
  - ventilation grille, aluminum
  - steel kick-plate with ventilation grille

## Construction:

- door leaf 100'
- door leaf 110'

## EXTRA-COST OPTIONS

- Accessories:**
- solid steel push-plate – one-sided
  - solid steel push-plate – two-sided
  - solid steel kick-plate – one-sided
  - solid steel kick-plate – two-sided

## ADDITIONAL INFORMATION

- other HPL decors (page 158) dostępne available upon individual enquiries: [inwestycje@classen.com.pl](mailto:inwestycje@classen.com.pl)
- decors not included in the standard offer are available with a rebate in brushed aluminum colour
- additional information: possibility of executing custom door leaves, door frames and glasses upon individual requests: [inwestycje@classen.com.pl](mailto:inwestycje@classen.com.pl)

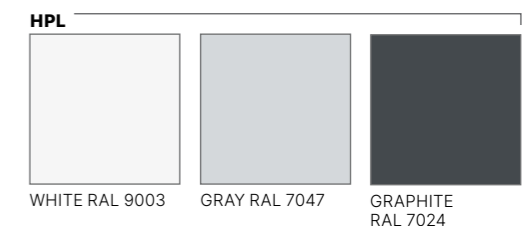
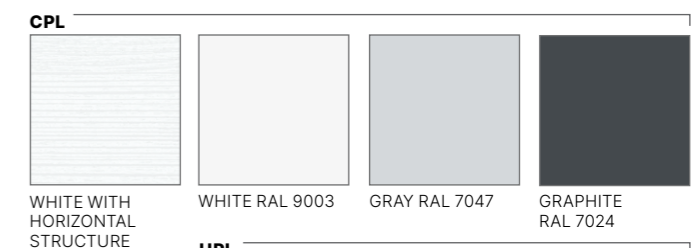



# BORD



model 1

vertical steel push-plate with room number (option)

MODELS

DETAILS

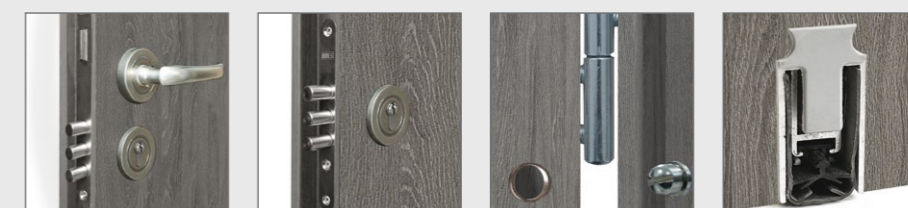

bottom deadbolt lock

top deadbolt lock

interlocking door bolt

falling threshold

BORD internal entrance door is designed for use in residential housing, public utility and collective residential buildings.

**DOOR SPECIFICATION**

- acoustic resistance - 32 dB for B46 W2 and W46 W2 door
  - if BORD MDF fixed door frame is used
  - if BORD steel fixed door frame is used
- three silver adjustable double-pin screw-in pintle hinges
- leaves thickness:
  - B40 - 40 mm, B46 and W46 - 46 mm

**DEDICATED DOOR FRAMES**

- BORD MDF fixed
- BORD steel fixed
- BORD steel corner
- HYBRYDA

**EXTRA-COST OPTIONS**

- Finish:**
- HPL laminates

**Construction:**

- door leaf and door frame 100'

**Accessories:**

- peephole
- falling threshold
- steel push-plate with room number
  - one-sided

**ADDITIONAL INFORMATION**

- spacing of holes in the lock:
  - lower deadbolt lock - 90 mm (B)
  - multipoint lock - 72 mm (W)
- cylinder locks and door handles do not constitute door leaf equipment
- cylinder lock size:
  - B40 - 26/36, B46 and W46 - 26/40
- technical approval: AT - 15-8467/2016
- possibility of executing custom doors and door frames upon individual requests:
  - inwestycje@classen.com.pl
- other HPL decors available upon individual enquiries:
  - inwestycje@classen.com.pl
- decors not included in the standard offer are available with a rebate in brushed aluminum colour

	B40 W1	B46 W1	B46 W2	W46 W1	W46 W2
reinforced peripheral frame made of softwood	✓	✓	✓	✓	✓
steel flat bars		✓	✓	✓	✓
perforated chipboard	✓	✓	✓	✓	✓
two deadbolt locks for cylinder lock	✓	✓	✓		
multipoint lock for cylinder lock				✓	✓
falling threshold and three interlocking door bolts			✓		✓

**PRIMO**



ACACIA ST BEECH NATURAL OAK WALNUT WHITE

**3D LOOK**



SONOMA OAK RIVIERA OAK WHITE ASH

**3D LOOK**



COLOMBIA LIGHT WALNUT OILED OAK BURNT OAK GRAY OAK ANTHRACITE OAK

**IRIDIUM**

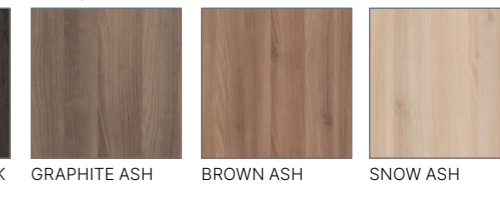

GRAPHITE ASH BROWN ASH SNOW ASH

**IRIDIUM**



MARONE OAK WENGE

**CPL**



ITALIAN WALNUT LIGHT ACACIA NORWEGIAN ASH

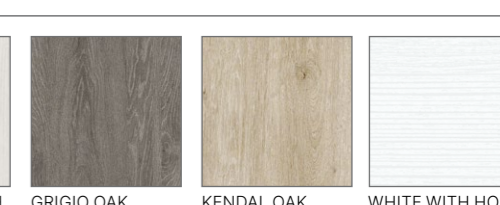

GRIGIO OAK KENDAL OAK WHITE WITH HORIZONTAL STRUCTURE

**CPL**



WHITE RAL 9003 GRAY RAL 7047 GRAPHITE RAL 7024

**HPL**



WHITE RAL 9003 GRAY RAL 7047 GRAPHITE RAL 7024

# BORD W3

TECHNICAL PANEL DOORS REBATED

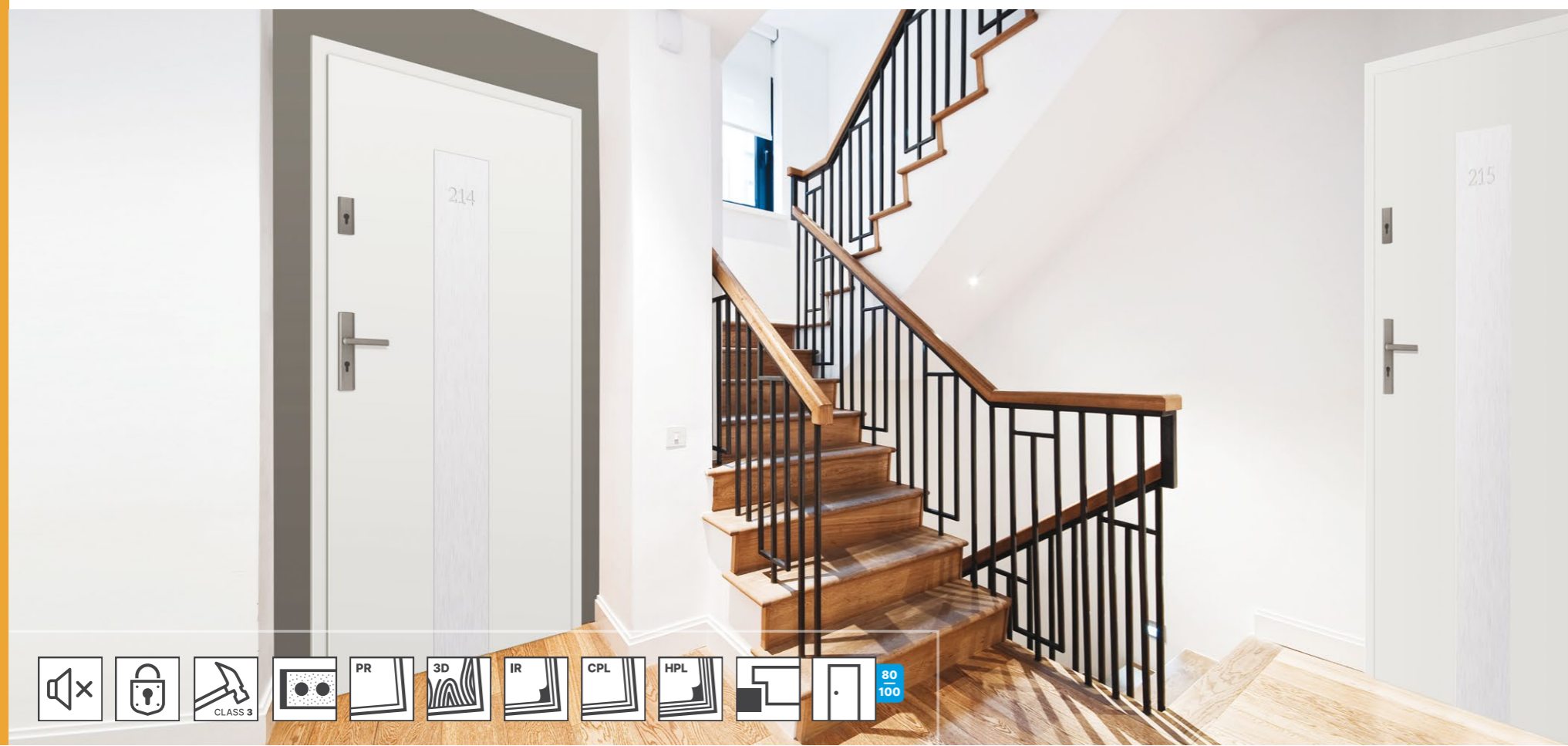

MODELS

DETAILS

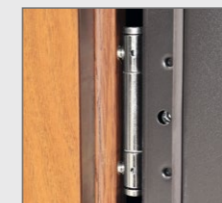

three-wing hinge

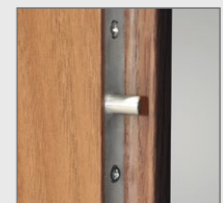

interlocking door bolts strip



multipoint lock

BORD W3 internal entrance door meet the requirements of the RC2 anti-burglary protection class, provided that the door is installed with a dedicated steel door frame (page 138), handle with escutcheon (page 153) and a set of cylinder locks fulfilling the second anti-burglary class (page 148).

Construction of a door leaf with thickness of 46 mm: peripheral frame made of softwood reinforced with special steel flat bar and a plywood. A perforated chipboard was used as a core. All is covered with wood-based board, veneered with Classen decors.

**DOOR SPECIFICATION**

- three anti-burglary three-way silver hinges
- Multistrong multi-point strip lock
- multipoint lock for cylinder lock (openings spacing 72 mm)
- leaf thickness: 46 mm
- door leaf available only with BORD W3 steel fixed door frame – (page 138)

**DEDICATED DOOR FRAMES**

- BORD W3 STEEL FIXED

**EXTRA-COST OPTIONS**

- Construction:**
- door leaf and door frame 100'
- Accessories:**
- peephole
  - transition threshold
  - falling threshold
  - steel push-plate with room number – one-sided

**ADDITIONAL INFORMATION**

- other HPL decors available upon individual enquiries: [inwestycje@classen.com.pl](mailto:inwestycje@classen.com.pl)
- decors not included in the standard offer are available with a rebate in brushed aluminum colour

**PRIMO**



**3D LOOK**

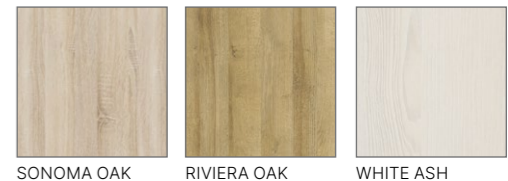

**3D LOOK**



**IRIDIUM**

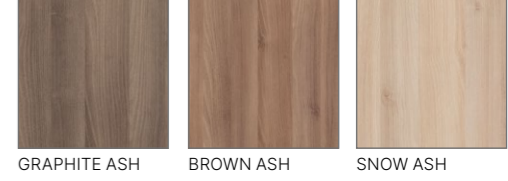

**IRIDIUM**



**CPL**



**CPL**

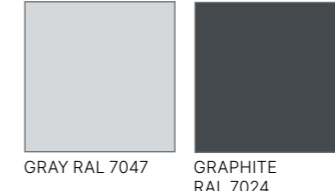

GRAY RAL 7047  
GRAPHITE RAL 7024

**HPL**

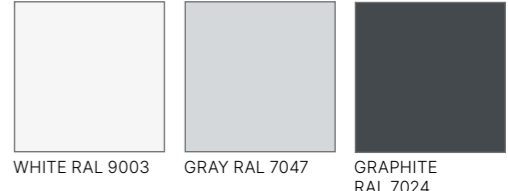

WHITE RAL 9003  
GRAY RAL 7047  
GRAPHITE RAL 7024

# FIRE DOORS - EI30 / EI60

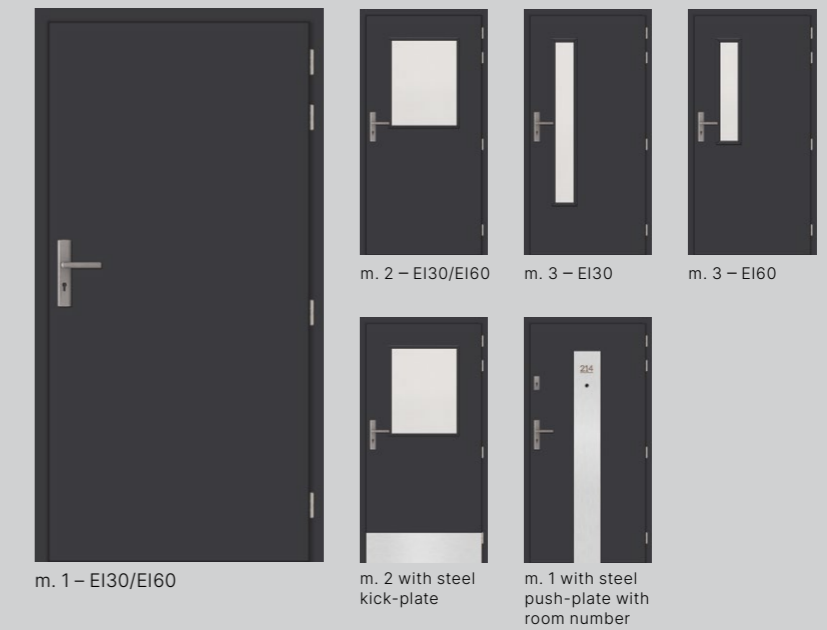
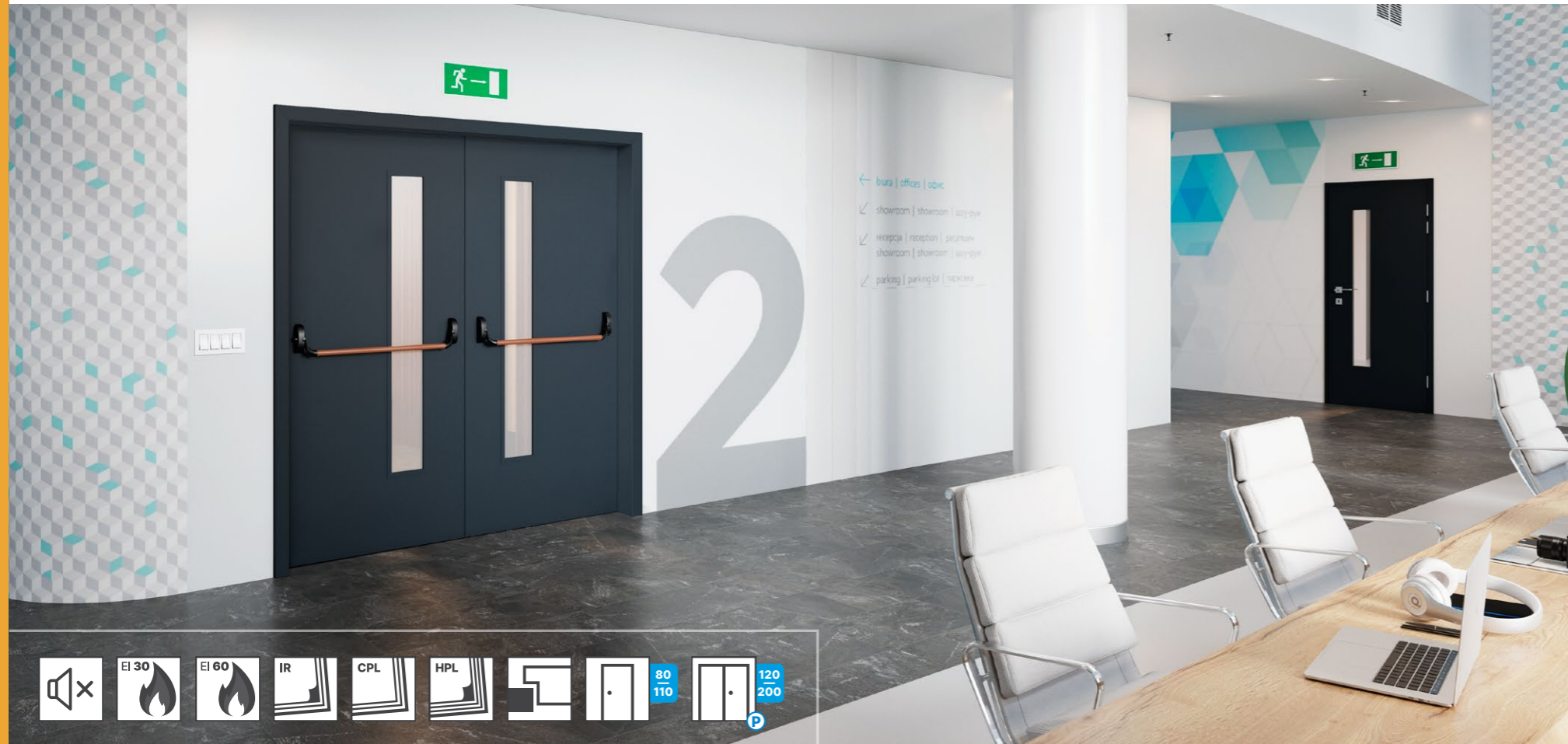

MODELS

DETAILS

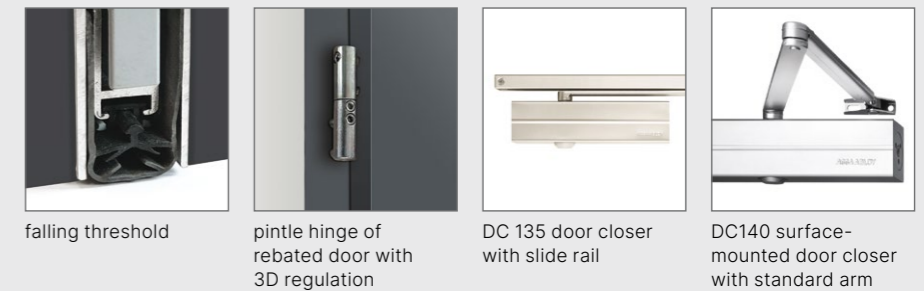

Internal entrance fire door is designed for use in residential housing, public utility and collective residential buildings as the door fulfilling the requirements for EI30 or EI60 fire resistance class,  $S_a$  and  $S_m$  smoke resistance class and acoustic resistance up to 32 dB.

## DOOR SPECIFICATION

- special two-layer board / peripheral frame made of softwood
- mortise latch lock for cylinder lock with insulation insert
- falling threshold – W2 version
- Hard Edge K door edge profile
- surface finish with Classen laminate: Iridium, CPL, HPL
- expanding seal in door leaf rebate
- four silver pintle hinges
- single leaf - acoustic resistance, version W2: 32 dB
- double leaf - acoustic resistance, version W2: 27 dB for EI30, 32 dB for EI60
- leaf thickness: EI30 – 50 mm, EI60 – 60 mm
- in glazed version: transparent glass with higher fire proof class
- openings spacing in the lock 72 mm
- EI 60 door leaf available with steel fixed door frame
- doors sold as a set with door frame

## DEDICATED DOOR FRAMES

- FIRE wooden fixed door frame
- FIRE steel fixed door frame

## EXTRA-COST OPTIONS

### Finish:

- HPL laminate

### Construction:

- door leaf and door frame 100'
- door leaf and door frame 101'
- door leaf and door frame 110'

### Accessories:

- steel threshold
- falling threshold
- solid steel push-plate – one-sided
- solid steel push-plate – two-sided
- solid steel kick-plate – one-sided
- solid steel kick-plate – two-sided

## DODATKOWE INFORMACJE

- **version W1** – does not have  $S_a$ ,  $S_m$  smoke-proof class and acoustic resistance (falling threshold)
- national technical approval: ITB-KOT-2018/0407 1st edition
- certificates of conformity: ITB Nr 020-UWB-2697/W
- in order to fulfill KOT requirements, fire door must be purchased together with a door-closer
- internal entrance doors only in full version
- cylinder locks and door handles do not constitute door leaf equipment
- cylinder locks size: EI 30 - 36x36; EI 60 – 36x46 (for handle escutcheons with a thickness of approx. 10 mm)
- size 91 and 101 meets the technical requirements for light opening width
- possibility to execute custom width and height of single and double door leaves upon individual enquiry: [inwestycje@classen.com.pl](mailto:inwestycje@classen.com.pl)

\* | HPL decors: door frames for HPL decors available in Iridium or CPL veneer. Colour differences regarding the shade are permissible. Other HPL decor (page 158) available upon individual enquiries: [inwestycje@classen.com.pl](mailto:inwestycje@classen.com.pl). (Decors outside the standard range are offered with the rebate in brushed aluminum colour.)

## IRIDIUM



## CPL



## CPL

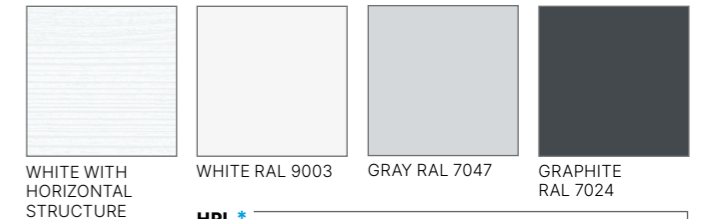

## HPL \*

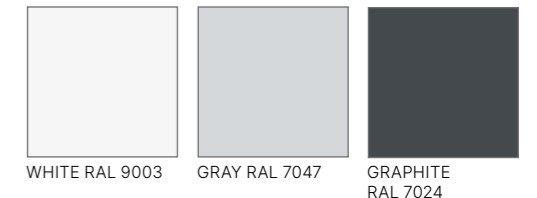

# ACOUSTIC DOORS – EI30 / 42 dB

TECHNICAL PANEL DOORS REBATED / NON-REBATED

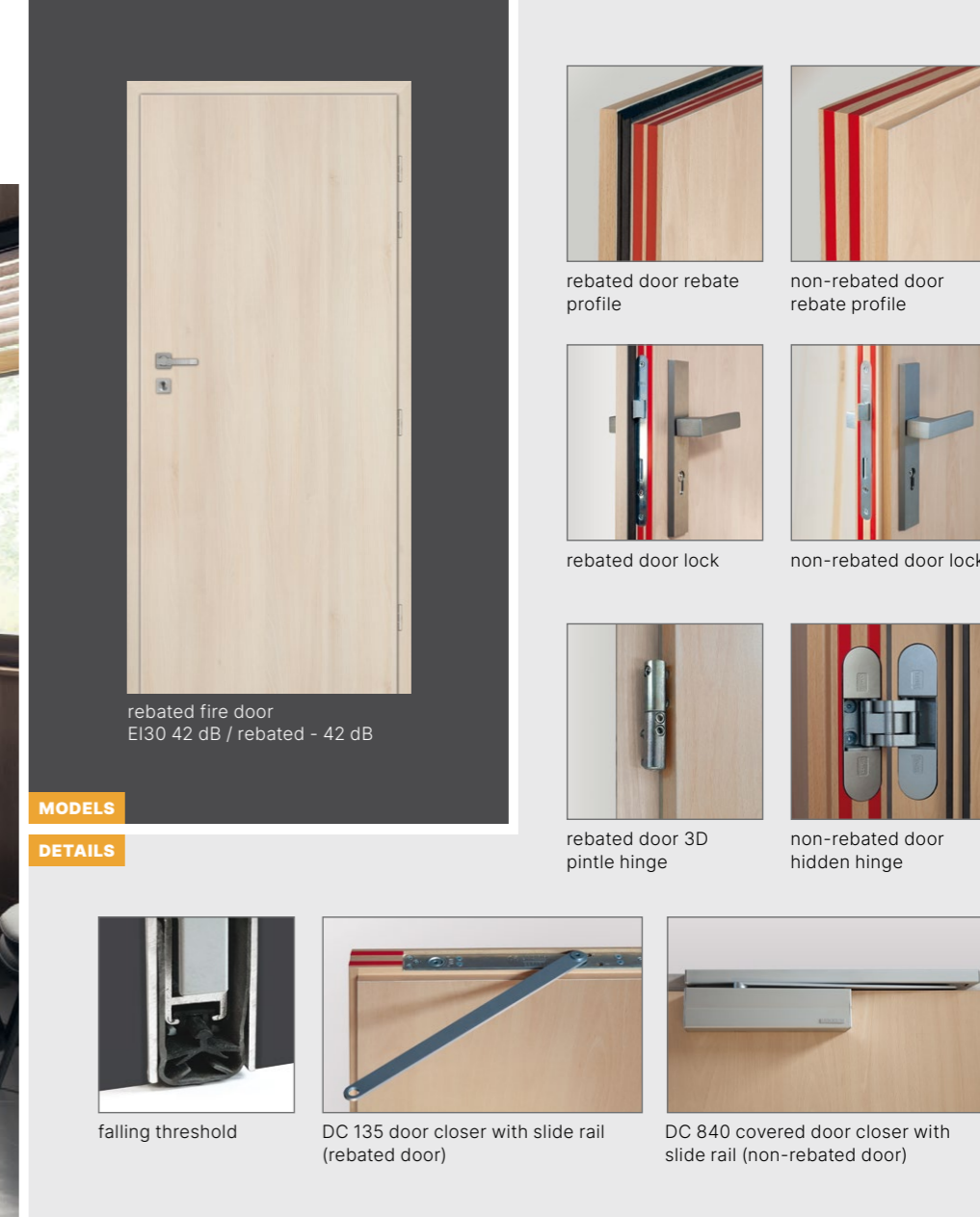

## EI30 / 42 dB FIRE DOORS

### DOOR SPECIFICATION

- construction: peripheral frame made of softwood with specialized board core, all covered with HDF board
- cylinder lock, spacing 72 mm
- single leaf 70'-90'
- falling threshold
- expanding seals
- mechanical resistance class 3 (acc. to PN-EN 1192:2001)

### K rebated door leaf: \*

- 4 pintle hinges
- additional seal in the rebate
- dedicated door frame: Fixed MDF 42dB

### B non-rebated door leaf: \*

- 4 hidden hinges
- dedicated door frame: Fixed non-rebated MDF 42dB

## 42 dB ACOUSTIC DOORS

### DOOR SPECIFICATION

- construction: peripheral frame made of softwood with specialized board core, all covered with MDF board
- cylinder lock, spacing 72 mm
- single leaf 60'-90'
- falling threshold
- mechanical resistance class 3 (acc. to PN-EN 1192:2001)

### K rebated door leaf: \*

- 4 pintle hinges
- additional seal in the rebate
- dedicated door frame: Fixed MDF 42dB

### B non-rebated door leaf: \*

- 4 hidden hinges
- dedicated door frame: Fixed non-rebated MDF 42dB

### ADDITIONAL INFORMATION

- national technical approval: ITB-KOT-2019/1154, 1st edition
- door can be used as entrance door
- in order to fulfill KOT requirements, fire door must be installed together with a door-closer
- cylinder locks size: 36/46 for rebated and non-rebated doors (for handle escutcheons with a thickness of approx. 10 mm)
- other HPL decors available upon individual enquiries: inwestycje@classen.com.pl
- decors not included in the standard offer are available with a rebate in brushed aluminum colour

### EXTRA-COST OPTIONS

#### Finish:

- Venom Alu

#### Accessories:

- solid steel push-plate – one-sided
- solid steel push-plate – two-sided
- solid steel kick-plate – one-sided
- solid steel kick-plate – two-sided

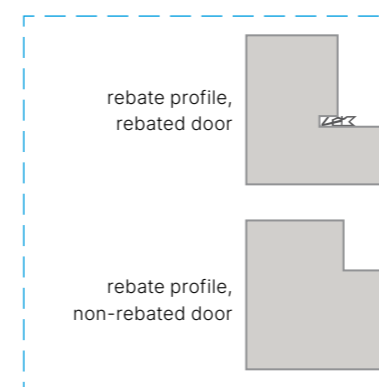

### IRIDIUM



### CPL



### CPL

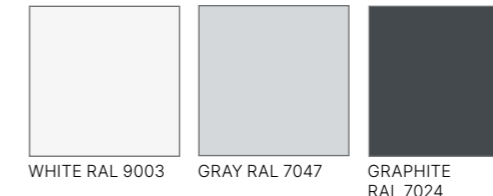

### HPL \*\*

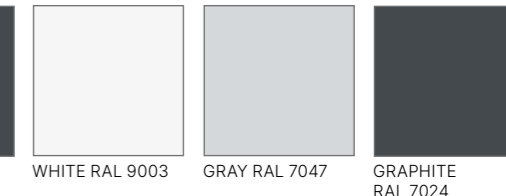

\* | Acoustic resistance:  
rebated:  $R_w(C;Ctr)=44 (-2;-6)$  dB  
non-rebated:  $R_w(C;Ctr)=44 (-2;-5)$  dB

\*\* | HPL decors: door frames for HPL decors available in Iridium or CPL veneer. Colour differences regarding the shade are permissible.

# VENOM



MODELS



## OPTIONAL MILLING PATTERNS AVAILABLE FOR BORD AND FIRE DOOR COLLECTIONS

### NOTE

- Available as an extra-cost option for full models from the BORD, BORD W3 and FIRE door collections.

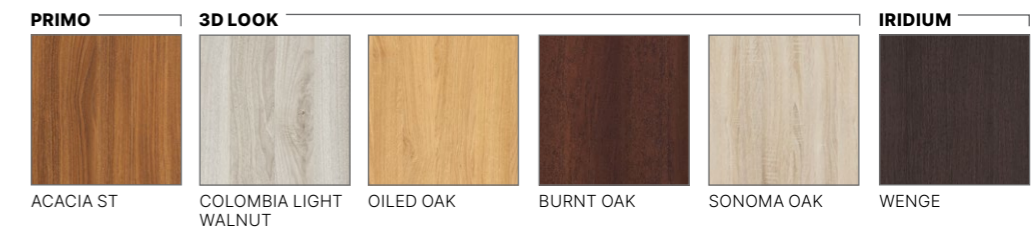

# VENOM ALU

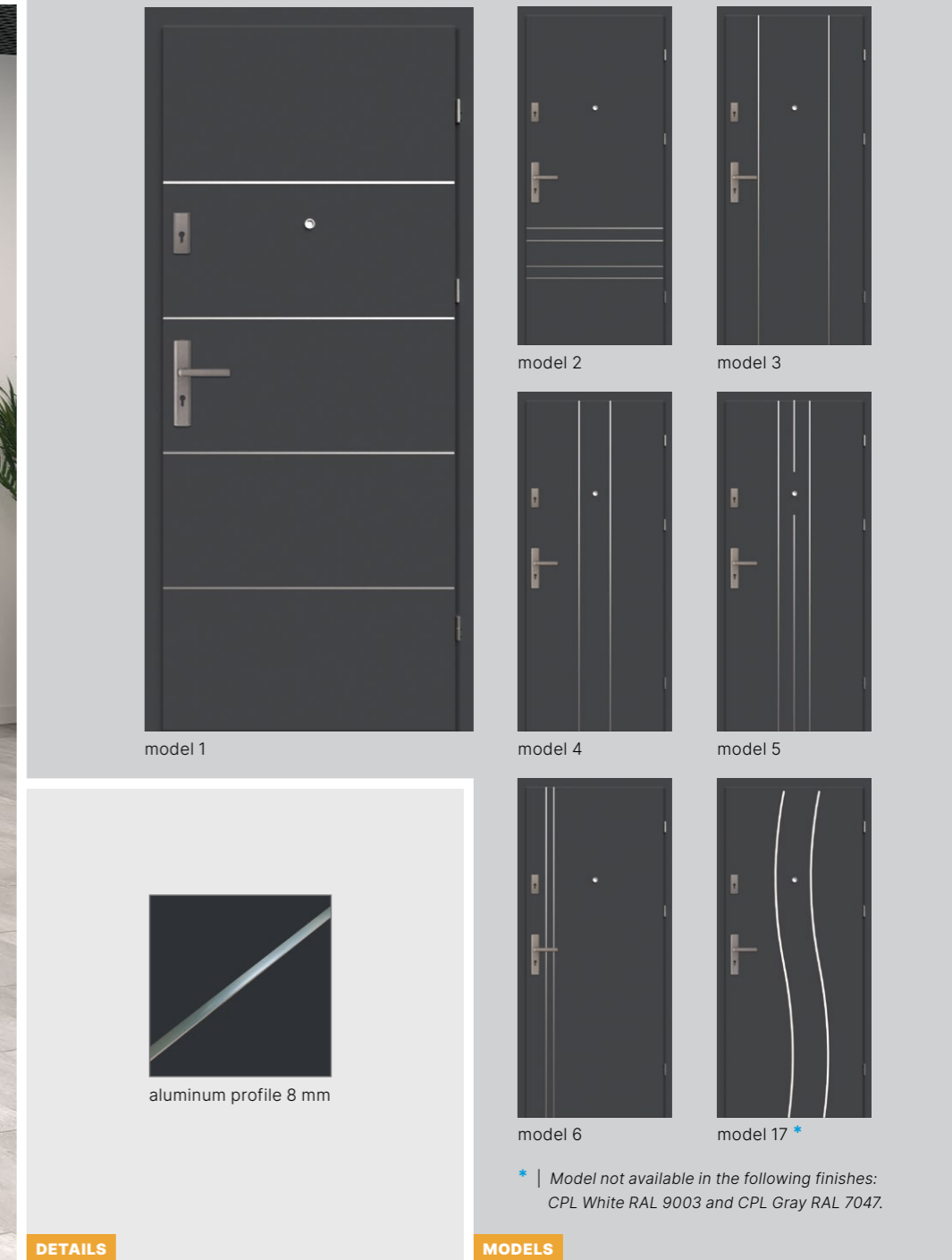

## OPTIONAL ALUMINUM INSERT FINISHES FOR THE BORD, BORD W3, FIRE, NATURA HK/HB CPL AND HPL AS WELL AS NATURA HR COLLECTIONS

### NOTE

- Available as an extra-cost option for full models from the BORD, BORD W3, FIRE, Natura HK/HB CPL, Natura HK/HB HPL and Natura HR door collections (in selected decors, with construction reinforced with perforated chipboard). Aluminium profile, width: 8 mm (colour – stainless steel / INOX), aligned with a door leaf surface.



# ACOUSTIC DOORS



MODELS



model 1 – 27 dB

model 1 – 32 dB

model 2 – 32 dB

model 3 – 32 dB

FULL: 27 dB – Rw (27–30)

### DOOR SPECIFICATION

- peripheral frame made of softwood, covered with HDF board
- 3 silver screw-in pintle hinges
- lock: mortice key lock / bathroom lock / cylinder lock / passage lock
- falling threshold

### DEDICATED DOOR FRAME

- Adjustable door frame  
Rw (C; Ctr)= 30(-1; -1) dB

FULL: 32 dB – Rw (32–34)

### DOOR SPECIFICATION

- specialized board, peripheral frame made of softwood, covered with HDF board
- 3 silver screw-in pintle hinges
- lock: mortice key lock / bathroom lock / cylinder lock / passage lock
- falling threshold

### DEDICATED DOOR FRAME

- Adjustable door frame  
Rw (C; Ctr)= 34 (-1; -2) dB
- Steel fixed door frame  
Rw (C; Ctr)= 32 (0;-1) dB

WITH GLAZING: 32 dB – Rw (32–33)

### DOOR SPECIFICATION

- safe transparent glass
- specialized board, peripheral frame made of softwood, covered with HDF board
- 3 silver screw-in pintle hinges
- lock: mortice key lock / bathroom lock / cylinder lock / passage lock
- falling threshold

### DEDICATED DOOR FRAME

- Adjustable door frame  
Rw (C; Ctr)= 32 (0;-2) dB
- Steel fixed door frame  
Rw (C; Ctr)= 33 (0;-2) dB

### ADDITIONAL INFORMATION

- acoustic resistance 27 dB (27–30 dB). Report from GLA-1144.3/13.
- acoustic resistance 32 dB (32–34 dB). Report from GLA-1166.2/14.a.

### EXTRA-COST OPTIONS

- **Construction:**
- door leaf 100'



Classen acoustic doors are available in all decors from the following groups: Primo, 3D Look, Iridium, CPL, HPL, lacquered except for white matt (details on page 154) and optionally in RAL palette colours.



## DOORS ALIGNED WITH THE WALL

This is the perfect choice for those looking for original solutions. No frames, hidden door frame and hinges, and a door leaf make this door perfectly blend with the wall. Thanks to this your room will turn into a mysterious casket, where the presence of the door can only be revealed by a discreet outline of the handle. Or maybe you want to experiment in a completely different style? This type of door may as well be distinguished by the original colour, bringing to mind an abstract painting filling the wall.





# COMPACT

DOORS ALIGNED WITH THE WALL



The Compact system consists of interior door leaf, veneered or for self-finishing and an aluminum door frame. After installation, the entire system forms a uniform surface with the wall.

### DOOR SPECIFICATION

- panel door leaf, solid, thickness: 40 mm
- external door leaf - non-rebated, opening outwards (height 2022 mm)
- internal door leaf - rebated, opening inwards (height 2032 mm)
- surface finishing: primer (surface prepared for self-finishing - painting \*), 3D Look and Iridium veneers, CPL and HPL laminates
- two openings for hidden hinges, adjustable (3 hinges for the width of 100' and height from 2222 to 2332 mm)
- magnetic lock: mortice key lock / bathroom lock / cylinder lock / passage lock

### EXTRA-COST OPTIONS

#### Ventilation:

- ventilation undercut
- ventilation undercut 15 mm (recuperation)

#### Construction:

- perforated chipboard
- door leaf 100'
- door leaf height 2132, 2122 mm
- door leaf height 2232, 2222 mm
- door leaf height 2332, 2322 mm

Extra-cost for width and height apply to door leaf and door frame.

#### Accessories:

- falling threshold

### DEDICATED DOOR FRAMES

#### Aluminum door frame:

- The frame is available in an external and internal version, raw, with the possibility of self-painting after impregnation.
- The package includes: 2 or 3 hinges, gaskets, impregnating agent, installation instruction and accessories needed for its installation.
- Installation of the frame on a raw wall requires application of plaster or drywall.

### INTERNAL DOOR FRAME

DOOR LEAF HEIGHT Hd	MOUNTING OPENING HEIGHT Ho	DOOR LEAF EXTERNAL HEIGHT Hz	CLEAR OPENING HEIGHT Hp	NUMBER OF HINGES
2032	2081	2074	2032	2
2132	2181	2174	2132	2
2232	2281	2274	2232	3
2332	2381	2374	2332	3

DOOR LEAF WIDTH Sd	MOUNTING OPENING WIDTH So	DOOR LEAF EXTERNAL WIDTH Sz	DOOR LEAF CLEAR OPENING WIDTH Sp
618	698	688	603
718	798	788	703
818	898	888	803
918	998	988	903
1018	1098	1088	1003

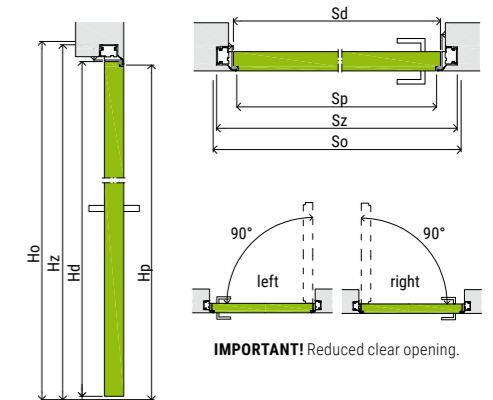
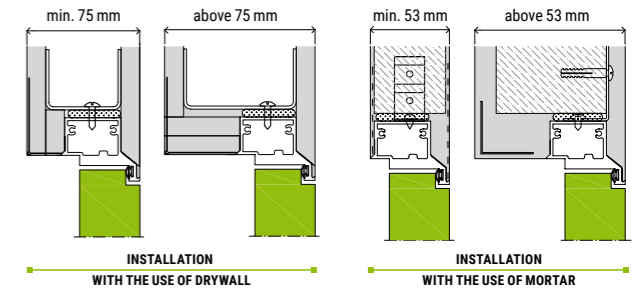

### EXTERNAL DOOR LEAF

DOOR LEAF HEIGHT Hd	MOUNTING OPENING HEIGHT Ho	DOOR LEAF EXTERNAL HEIGHT Hz	CLEAR OPENING HEIGHT Hp	NUMBER OF HINGES
2022	2071	2064	2022	2
2122	2171	2164	2122	2
2222	2271	2264	2222	3
2322	2371	2364	2322	3

DOOR LEAF WIDTH Sd	MOUNTING OPENING WIDTH So	DOOR LEAF EXTERNAL WIDTH Sz	DOOR LEAF CLEAR OPENING WIDTH Sp
618	698	688	603
718	798	788	703
818	898	888	803
918	998	988	903
1018	1098	1088	1003

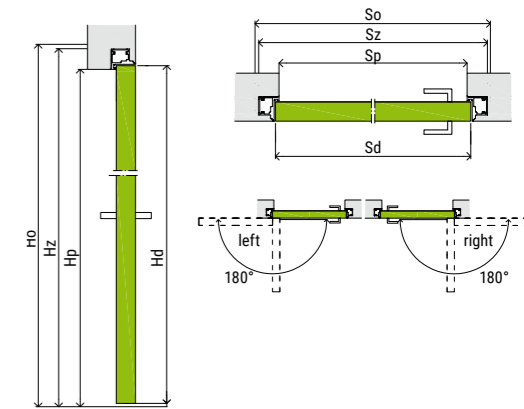
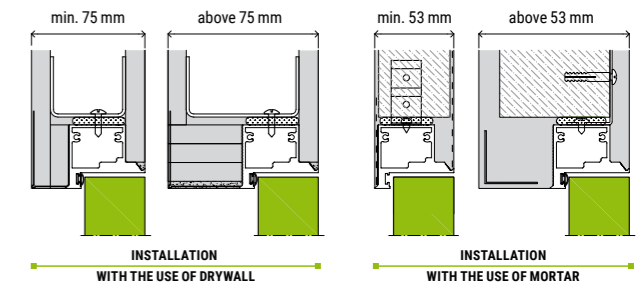

Classen doors in the Compact system are available in all decors from the following groups: Primo, 3D Look, Iridium, CPL, HPL, lacquered (details on page 154-157). HPL decors – only standard offer.



\* | Tests conducted using original wall paints available on the market.

# SLIDING DOOR SYSTEMS

A way to create an original entrance to the room. They ensure comfortable use and freedom of movement. They are perfect for small spaces, where using traditional doors is a really hard task. They also do a great job on a larger surface, catching the eye and giving the interior a modern, dynamic character. They are available in single and double leaf versions. They also differ depending on the installation method - they can be retracted into the wall or intended for on-wall mounting. Leaves can be chosen from many models with different aesthetics, which is why everyone will find an option ideally suited to their interior.



SLIDING DOOR SYSTEMS



DO YOU WANT TO SAVE SOME SPACE IN THE FLAT?

Sliding doors will help you with that. Thanks to the convenient way of opening and closing, they do not use additional space. Especially recommended for interiors where every centimeter is important.

NON-OBVIOUS DECORATION.

The door can play the first fiddle in interior design. Especially double leaf models that look very impressive. In spacious rooms they will hit the bullseye.



# ON-WALL SLIDING DOOR SYSTEM



DOUBLE LEAF SLIDING DOOR SYSTEM

## SINGLE LEAF SLIDING DOOR SYSTEM

- Single leaf on-wall sliding door system consists of a sliding mechanism, masking element (including a bumper beam). The door leaf must be purchased separately.
- As a standard, the system is installed directly on the wall, optionally it can be installed with a tunnel frame which must be purchased separately.
- Single leaf mechanism is equipped with a 2.5 m long rail, which should be cut to the final size.
- Single leaf sliding door system is offered in the following dimensions: 60', 70', 80', 90', 100'.

## DOUBLE LEAF SLIDING DOOR SYSTEM

- Double leaf on-wall sliding door system consists of a sliding mechanism, masking element. The door leaves must be purchased separately.
- Double leaf on-wall sliding system is opened synchronously, i.e. by sliding one leaf, both door leaves open at the same time. Synchronous system requires ordering two door leaves of the same width.
- Double leaf mechanism is equipped with two 2.5 m long rails and masking elements, which should be cut to the final size.
- As a standard, the system is installed directly on the wall,

optionally it can be installed with a tunnel frame which must be purchased separately.

- Double leaf sliding system is offered in the following dimensions: 120', 140', 160', 180', 200' (for doors opening synchronously).
- Door leaves for the sliding door system are manufactured in non-rebated version in the external dimensions of rebated door, e.g.: 844 x 2035 mm (80').

## AVAILABILITY

- Sliding door system is available in all decors and collections apart from the following collections: Classic, Andromeda, Salvano.

## EXTRA-COST OPTIONS



door closer



hook lock (mortice key lock, bathroom lock)



SINGLE LEAF SLIDING DOOR SYSTEM

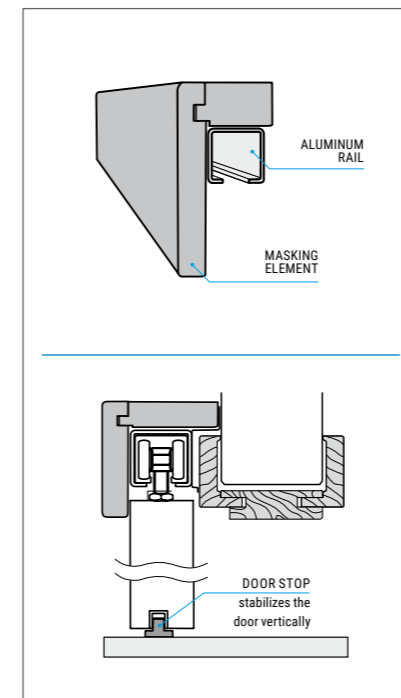

VERTICAL CROSS-SECTION OF THE SLIDING SYSTEM

## PULL HANDLES INSTALLED IN SLIDING DOORS AS AN EXTRA-COST OPTION.

THE COLOUR OF THE PULL HANDLE ASSIGNED TO A GIVEN DECOR.

### PCV PULL HANDLES



WHITE

**Primo:** White  
**3D Look:** White Ash  
**Iridium:** White Matt  
**CPL:** White RAL 9003, White with horizontal structure  
**Lacquered**



BEIGE

**Primo:** Beech, Natural Oak, Polish Oak  
**3D Look:** Oiled Oak, Sonoma Oak, Riviera Oak  
**Iridium:** Snow Ash, Brown Ash, Marrone Oak



SILVER

**3D Look:** Colombia Light Walnut, Gray Oak, Anthracite Oak  
**Iridium:** Graphite Ash, Gray Matt, Wenge  
**CPL:** Light Acacia, Gray RAL 7047, Graphite RAL 7024, Grigio Oak, Kendal Oak, Norwegian Ash



BROWN

**Primo:** Acacia St, Walnut  
**3D Look:** Roasted Oak, Catania Oak  
**CPL:** Italian Walnut

### STEEL PULL HANDLES



BLACK



NICKEL

**Primo**  
**3D Look**  
**Iridium**  
**CPL**  
**Lacquered**

Classen sliding doors are available in all decors from the following groups (details on page 154–157) and optionally in RAL palette colours.

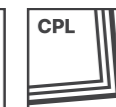
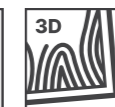

# DIVA

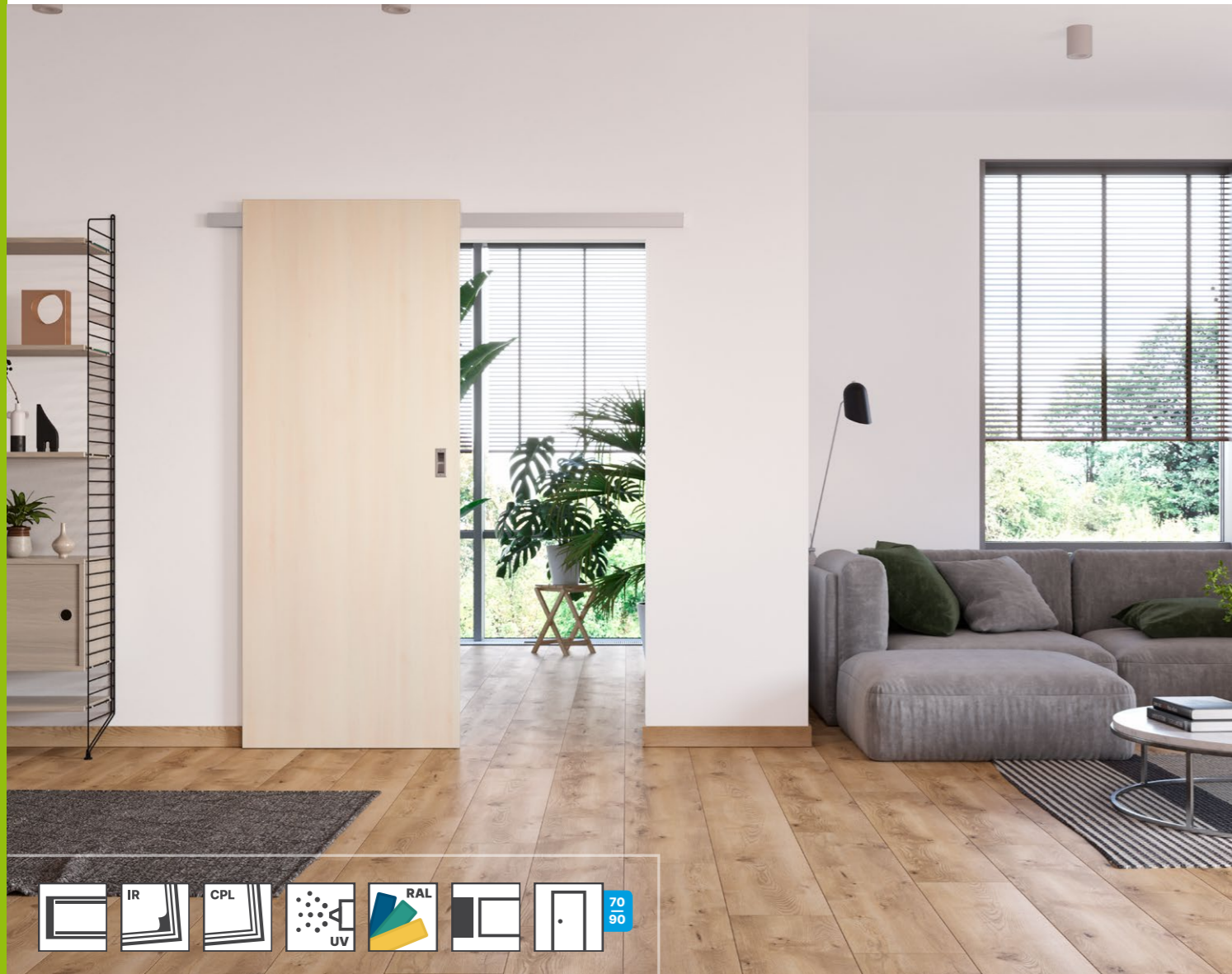

Thanks to a wide, aluminum rail, partially recessed in the door leaf, Diva System creates an aesthetic and modern combination of the door and the sliding system.

The system consists of the mechanism and the door leaf and is designed for mounting directly on the wall (no possibility of assembly with the tunnel).



DOOR LEAF WITH A RAIL – CONNECTION METHOD

## DOORLEAF

- Sliding, single leaf, solid, HARD construction, equipped with stainless steel INOX pull handle as a standard. Dedicated exclusively to Diva system.
- Door leaf dimensions - 744, 844, 944 x 2135 mm.

## MECHANISM

- A full set consists of a 2 m aluminum rail, hardware and installation instruction.
- Two types of mechanism are available – standard one and with a self-closing system. After installing the system, the gap between the leaf and the wall is 12 mm.

## EXTRA-COST OPTIONS

- RAL palette colours



	DOOR LEAF HEIGHT Hd	WALL OPENING HEIGHT Ho	DOOR LEAF WIDTH Sd	WALL OPENING WIDTH So
70'	2135	2000	744	700
80'			844	800
90'			944	900

**DIVA SYSTEM DIMENSION TABLE**

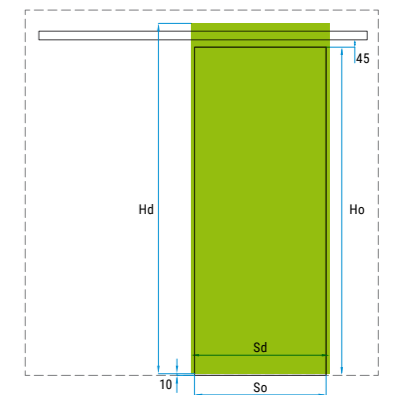

## IRIDIUM



GRAPHITE ASH BROWN ASH SNOW ASH

## CPL



ITALIAN WALNUT LIGHT ACACIA NORWEGIAN ASH WHITE WITH HORIZONTAL STRUCTURE

## CPL



GRIGIO OAK KENDAL OAK WHITE RAL 9003 GRAY RAL 7047 GRAPHITE RAL 7024

## LACQUER

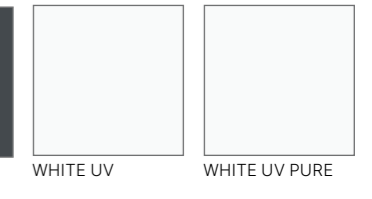

WHITE UV WHITE UV PURE



POCKET MODEL	LIGHT OPENING L X H	EXTERNAL DIMENSIONS			THICKNESS OF POCKET / WALL *	INTERNAL DIMENSIONS	DOOR LEAF DIMENSIONS	
		C X H1	A	B			LP	HP
G60 plus	610 x 2025	1350 x 2110	670	640	100 **	53	644	2035
G70 plus	710 x 2025	1550 x 2110	770	740			744	
G80 plus	810 x 2025	1750 x 2110	870	840			844	
G90 plus	910 x 2025	1950 x 2110	970	940			944	
G100 plus **	1010 x 2025	2150 x 2110	1070	1040			1044	

SINGLE POCKET DIMENSION TABLE

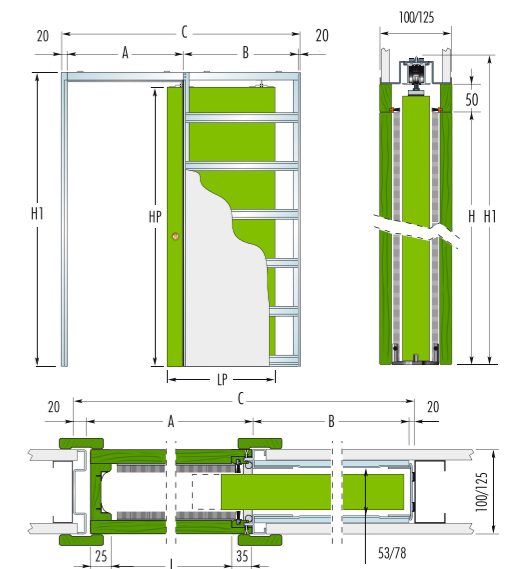

A modern sliding system perfect for loft interiors. The black steel rail and all other elements of the set give the whole a unique industrial character.

The system is designed for installation directly on the wall, available only in a single-leaf version.

Door leave height: 2035 mm, available in widths 70', 80', 90' with a black recessed steel handle. Doors must be purchased separately, they are available in all collections and decors except: Classic, Andromeda, Salvano.

### EXTRA-COST OPTIONS

#### STOPPER



SLIDING SYSTEM WITH A STOPPER

#### SELF-CLOSING SYSTEM



SILENT, SELF-CLOSING SYSTEM

#### STEEL PULL HANDLES



STEEL BLACK

### PACKAGE

- Includes a complete sliding system with a 1950 mm long rail. A door closer is also available for an extra charge.

POCKET MODEL	LIGHT OPENING L X H	EXTERNAL DIMENSIONS			THICKNESS OF POCKET / WALL *	INTERNAL DIMENSIONS	DOOR LEAF DIMENSIONS	
		C X H1	A	B			LP	HP
GG60 plus	1210 x 2025	2600 x 2110	1280	640	100 **	54	644	2035
GG70 plus	1410 x 2025	3000 x 2110	1480	740			744	
GG80 plus	1610 x 2025	3400 x 2110	1680	840			844	
GG90 plus	1810 x 2025	3800 x 2110	1880	940			944	
GG100 plus	2010 x 2025	4200 x 2110	2080	1040			1044	

DOUBLE POCKET DIMENSION TABLE

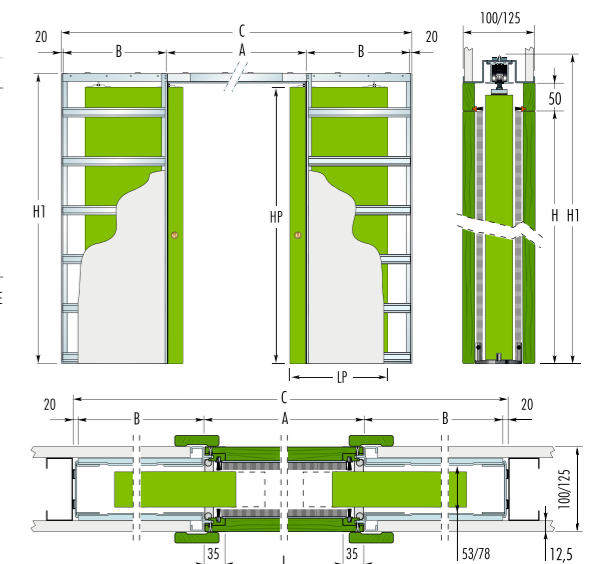

\* | Eclisse door frames for non-standard wall thickness should be ordered in line with the order form. Door frame decors: Primo, 3D Look, Iridium and CPL, except following decors: Catania Oak, Gray Oak, Gray matt, Marone Oak and White with horizontal structure.

\*\* | Pocket with a thickness of 100 mm - possibility of assembly of all collections except for glazed models in pane doors.

# Wood-based door frames

This group of door frames is intended for everyday use door leaves used in apartments and offices. All these frames can be used with lacquered, frame and panel doors produced by Classen.

In this section you will find frames of a universal character, e.g. Adjustable or Standard 2-pack fixed, but also the more decorative ones, such as Arcus and New Arcus. The CMOK door frame, on the other hand, is a product intended for installation on the old type of steel door frames without the need to disassemble them.

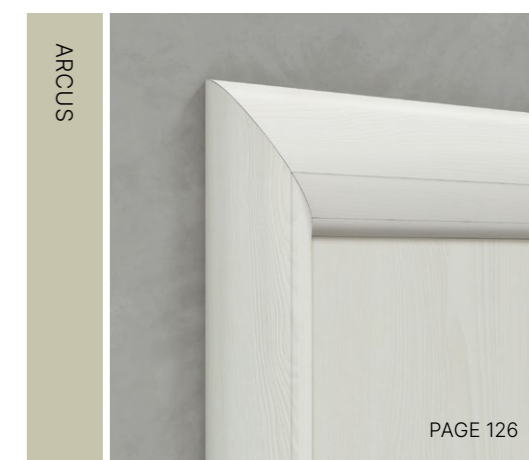

*View from the inner side of the leaf. Outer side as in the Standard 2-Pack fixed door frame.*

# ADJUSTABLE / ADJUSTABLE 80

# NON-REBATED ADJUSTABLE / ADJUSTABLE 80



### EXECUTION STANDARD

- Adjustable door frames are made of chipboard and MDF, covered with Classen decors or lacquered, in colours corresponding to door leaves colours.
- Also available in Tunel version.

### Packaging:

- Complete door frame consists of an upper beam and a base and it constitutes one package. The set includes hardware, gaskets and an assembly set. For door leaves with the dimension of 100' or reinforced leaves, it is required to use door frame with three hinges.

### COLOURS

#### Primo

- Acacia ST, White, Natural Oak, Beech, Polish Oak, Walnut

#### 3D Look\*

- Roasted Oak, Oiled Oak, White Ash, Sonoma Oak, Colombia Light Walnut, Riviera Oak, Gray Oak, Anthracite Oak, Catania Oak

#### Iridium

- White Matt\*, Gray Matt, Snow Ash, Brown Ash, Graphite Ash\*, Wenge, Marrone Oak\*

#### CPL

- Light Acacia\*, White 9003\*, Gray 7047, Graphite 7024, Italian Walnut\*, Norwegian Ash\*, Kendal Oak\*, Grigio Oak\*, White with horizontal structure

#### Lacquer\*

- lacquer: White UV or PU

### EXTRA-COST OPTIONS

- third hinge
- door frame 100'
- door frame 110'
- door frame 120'
- PN 22 door frame height
- PN 23 door frame height
- band 80
- door frame for double leaf door
- RAL colours

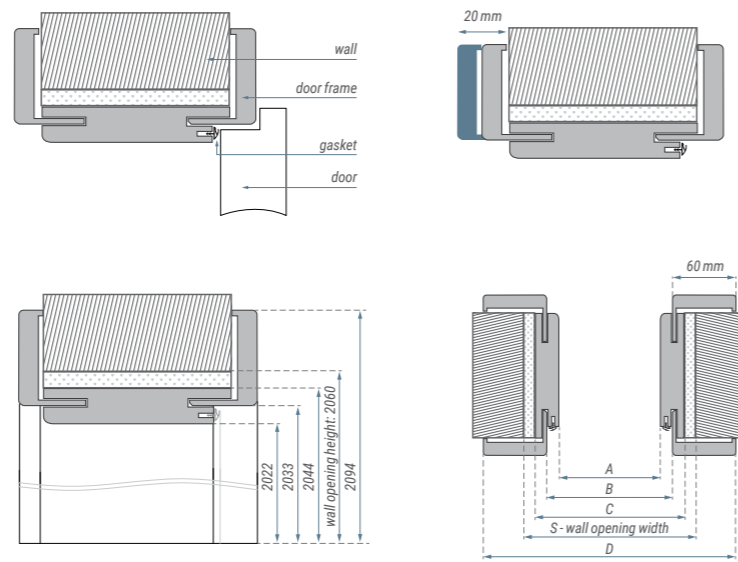

▲ ADJUSTABLE DOOR FRAME

▼ ADJUSTABLE 80 DOOR FRAME

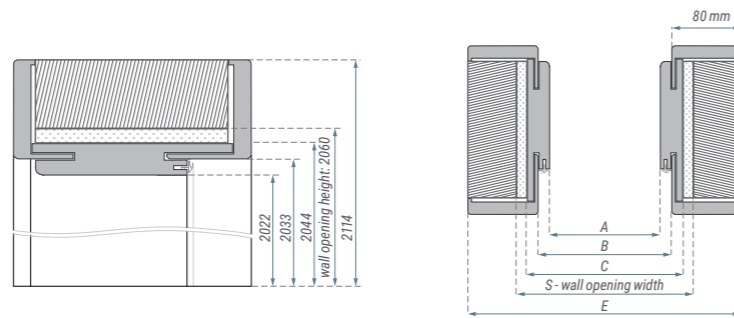

Crowns and a cover strip are designed for installation with Adjustable door frame (single leaf).



More information on page 147.

Dimensions of the adjustable door frame [mm]:							Adjustment range [mm]:								
	A	B	C	D	E	S	A	B	C	D	E	S	75-95	220-240	
60	603	625	648	748	788	675	100	1038	1061	1083	1183	1223	1110	95-115	240-260
70	703	726	748	848	888	775	110	1138	1161	1183	1283	1323	1210	120-140	260-280
80	803	826	848	948	988	875	120	1238	1261	1283	1383	1423	1310	140-160	280-300
90	903	926	948	1048	1088	975	130	1338	1361	1383	1483	1523	1410	160-180	300-320
100	1003	1026	1048	1148	1188	1075	140	1438	1461	1483	1583	1623	1510	180-200	320-340
110	1103	1126	1148	1248	1288	1175	150	1538	1561	1583	1683	1723	1610	200-220	340-360
120	1203	1226	1248	1348	1388	1275	160	1638	1661	1683	1783	1823	1710		
<b>SINGLE LEAF</b>							170	1738	1761	1783	1883	1923	1810		
							180	1838	1861	1883	1983	2023	1910		
							190	1938	1961	1983	2083	2123	2010		
							200	2038	2061	2083	2183	2223	2110		
<b>DOUBLE LEAF</b>															

\* | Adjustable 80 door frame available in marked decors. Not available in Natura HK CPL - PN22 and PN23 models.



### EXECUTION STANDARD

- Adjustable Non-rebated door frames are made of chipboard and MDF, covered with Classen decors or lacquered, in colours corresponding to door leaves colours. Door frames dedicated for non-rebated door leaves.

### Packaging:

- Complete non-rebated door frame consists of an upper beam and a base and it constitutes one package. The set includes two non-rebated hidden hinges, gaskets and an assembly set.

### COLOURS

#### Primo

- White
- Iridium

- Snow Ash, Brown Ash, Graphite Ash\*, Wenge

#### CPL

- Light Acacia\*, White 9003\*, Gray 7047, Graphite 7024, Italian Walnut\*, Norwegian Ash\*, Kendal Oak\*, Grigio Oak\*, White with horizontal structure.

#### Lacquer\*

- lacquer: White UV or PU

### EXTRA-COST OPTIONS

- door frame 100'
- band 80
- RAL colours

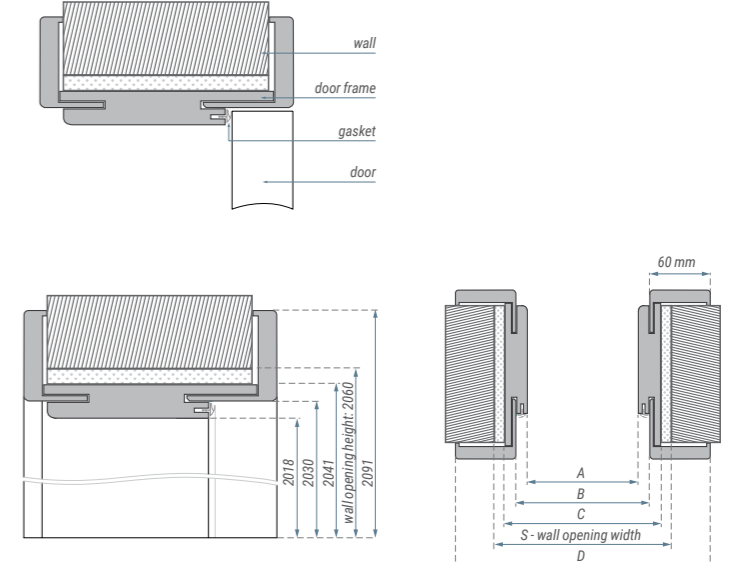

▲ ADJUSTABLE NON-REBATED DOOR FRAME

▼ ADJUSTABLE 80 NON-REBATED DOOR FRAME

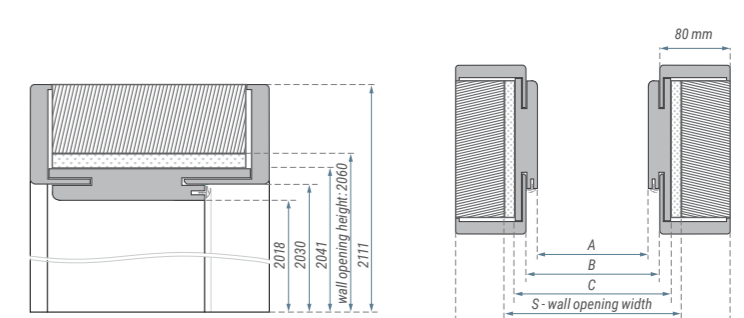

Crowns and a cover strip are designed for installation with Adjustable door frame (single leaf).



3D hinge



Strike plate with adjustment

More information on page 147.

Dimensions of the adjustable non-rebated door frame [mm]:							Adjustment range [mm]:	
	A	B	C	D	E	S	90-110	235-255
60	601	624	646	746	786	690	110-130	255-275
70	701	724	746	846	886	790	135-155	275-295
80	801	824	846	946	986	890	155-175	295-315
90	901	924	946	1046	1086	990	175-195	315-335
100	1001	1024	1046	1146	1186	1090	195-215	335-355
							215-235	355-375

\* | Adjustable 80 door frame available in marked decors. Not available in Natura HB CPL - PN22 and PN23 models.

# ARCUS

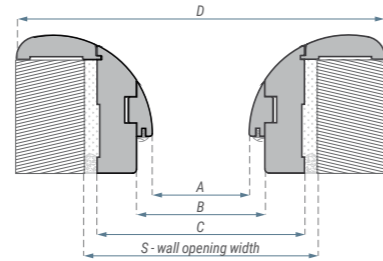
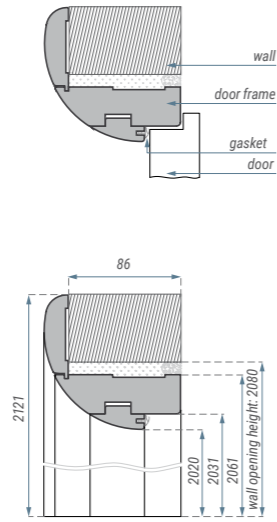

## EXECUTION STANDARD

- Arcus door frames are made of MDF, covered with Primo, 3D Look and Iridium veneer and Classen CPL laminate in decors corresponding to door leaves decors. Base elements have been integrated on one side with finishing mouldings.
- Also available in Tunel version.

## Packaging:

- Complete door frame consists of an upper beam and a base (two separate packages), equipped with two silver pintle hinges (the third hinge – as an extra-cost option). For door leaves with the dimension of 100' or reinforced leaves, it is required to use door frame with three hinges.

## COLOURS

### Primo

- Acacia ST, White, Natural Oak, Polish Oak, Walnut

### 3D Look

- Roasted Oak, White Ash, Colombia Light Walnut, Gray Oak

### Iridium

- Brown Ash, Graphite Ash, Wenge

### CPL

- Light Acacia, Italian Walnut, Norwegian Ash, White with horizontal structure

## EXTRA-COST OPTIONS

- third hinge
- door frame 100'
- door frame for double leaf door

Dimensions of Arcus door frame [mm]:

	A	B	C	D	S		A	B	C	D	S
60	602	626	686	806	710	100	1037	1061	1121	1241	1145
70	702	726	786	906	810	110	1137	1161	1221	1341	1245
80	802	826	886	1006	910	120	1237	1261	1321	1441	1345
90	902	926	986	1106	1010	130	1337	1361	1421	1541	1445
100	1002	1026	1086	1206	1110	140	1437	1461	1521	1641	1545
<b>SINGLE LEAF</b>						150	1537	1561	1621	1741	1645
						160	1637	1661	1721	1841	1745
						170	1737	1761	1821	1941	1845
						180	1837	1861	1921	2041	1945
						190	1937	1961	2021	2141	2045
						200	2037	2061	2121	2241	2145

## DOUBLE LEAF

# NEW ARCUS

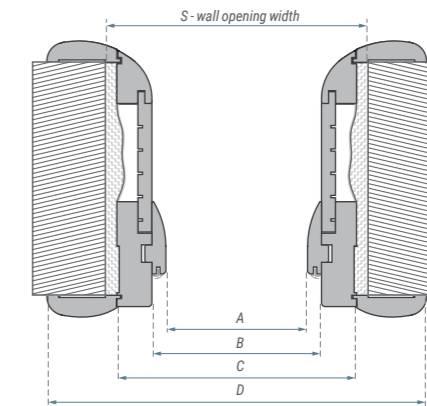
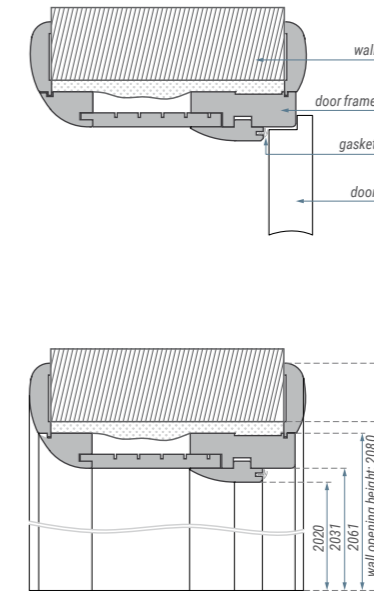

## EXECUTION STANDARD

- New Arcus door frames are made of MDF, covered with Primo, 3D Look and Iridium veneer and Classen CPL laminate in decors corresponding to door leaves decors. Besides modern design, the advantage of this door frame is its universal application – for the purpose of adjustment to different wall thickness, this door frame is available in two adjustment ranges: 115-200 mm and 200-320 mm.
- Also available in Tunel version.

## Packaging:

- Complete door frame consists of an upper beam and a base (two separate packages), equipped with two silver pintle hinges (the third hinge – as an extra-cost option). For door leaves with the dimension of 100' or reinforced leaves, it is required to use door frame with three hinges.

## COLOURS

### Primo

- Acacia St, Walnut

### 3D Look

- Roasted Oak, White Ash, Colombia Light Walnut, Gray Oak

### Iridium

- Brown Ash, Graphite Ash, Wenge, Marrone Oak

### CPL

- Light Acacia, Italian Walnut, Norwegian Ash, Kendal Oak, Grigio Oak

## EXTRA-COST OPTIONS

- adjustment insert 200-320 mm
- third hinge
- door frame 100'
- door frame for double leaf door

Dimensions of New Arcus door frame [mm]:

	A	B	C	D	S		A	B	C	D	S
60	602	626	686	806	710	100	1037	1061	1121	1241	1145
70	702	726	786	906	810	110	1137	1161	1221	1341	1245
80	802	826	886	1006	910	120	1237	1261	1321	1441	1345
90	902	926	986	1106	1010	130	1337	1361	1421	1541	1445
100	1002	1026	1086	1206	1110	140	1437	1461	1521	1641	1545
<b>SINGLE LEAF</b>						150	1537	1561	1621	1741	1645
						160	1637	1661	1721	1841	1745
						170	1737	1761	1821	1941	1845
						180	1837	1861	1921	2041	1945
						190	1937	1961	2021	2141	2045
						200	2037	2061	2121	2241	2145

## DOUBLE LEAF



# STANDARD 2-PACK FIXED

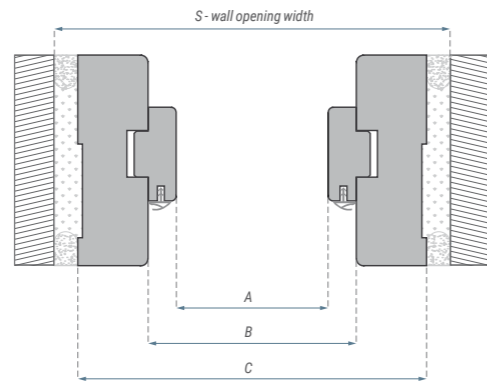
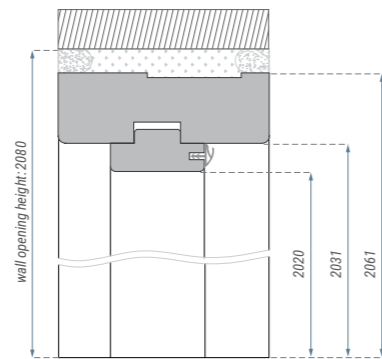
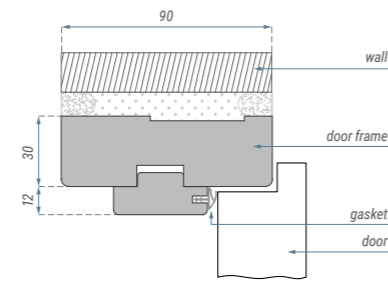

## EXECUTION STANDARD

- Standard 2-pack fixed door frames are made of MDF, covered with Primo, 3D Look and Iridium veneer and CPL laminate in decors corresponding to door leaves decors.

## Packaging:

- Complete door frame consists of an upper beam and a base (two separate packages), equipped with two silver pintle hinges (the third hinge – as an extra-cost option). For door leaves with the dimension of 100' or reinforced leaves, it is required to use door frame with three hinges.

## COLOURS

### Primo

- Acacia ST, White, Natural Oak, Beech, Polish Oak, Walnut

### 3D Look

- Oiled Oak, Roasted Oak, White Ash, Sonoma Oak, Colombia Light Walnut, Riviera Oak, Gray Oak, Anthracite Oak, Catania Oak

### Iridium

- Snow Ash, Brown Ash, Graphite Ash, Wenge, White Matt, Gray Matt, Marrone Oak

### CPL

- Light Acacia, White 9003, Gray 7047, Graphite 7024, Norwegian Ash, Kendal Oak, Grigio Oak, White with horizontal structure

### Lacquer

- White UV or PU

## EXTRA-COST OPTIONS

- third hinge
- door frame 100'
- door frame 110'
- door frame 120'
- door frame for double leaf door

Dimensions of Std 2-pack door frame [mm]:

	A	B	C	S		A	B	C	S
60	602	626	686	710	100	1037	1061	1121	1145
70	702	726	786	810	110	1137	1161	1221	1245
80	802	826	886	910	120	1237	1261	1321	1345
90	902	926	986	1010	130	1337	1361	1421	1445
100	1002	1026	1086	1110	140	1437	1461	1521	1545
110	1102	1126	1186	1210	150	1537	1561	1621	1645
120	1202	1226	1286	1310	160	1637	1661	1721	1745
<b>SINGLE LEAF</b>					170	1737	1761	1821	1845
					180	1837	1861	1921	1945
					190	1937	1961	2021	2045
					200	2037	2061	2121	2145

SINGLE LEAF

DOUBLE LEAF

# CMOK

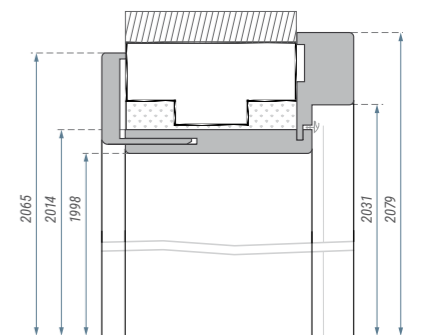
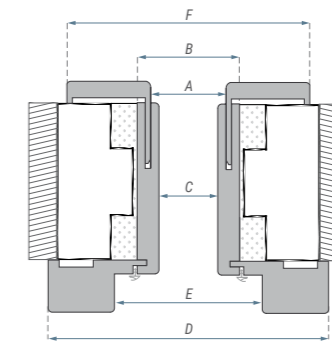
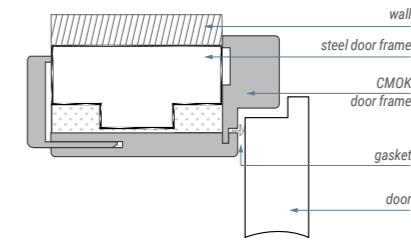

## EXECUTION STANDARD

- Adjustable single door leaf frame, designed to be installed on steel door frame, without the need to dismantle it beforehand. It allows the exchange of door leaves while maintaining their current dimensions. A distinctive feature of this door frame is a quick and easy installation possible owing to permanent fixture of two base elements. The door frame is entirely made of wood-based material – MDF, covered with Primo, 3D and Iridium decors and CPL laminates.

## Packaging:

- A complete door frame is available in two adjustment ranges: 70-110 mm and 110-150 mm. Both ranges are available in a single package, which also contains a gasket and assembly bag. For door leaves with a dimension 100' and reinforced door leaves it is required to use a door frame with three hinges.

## COLOURS

### Primo

- Acacia ST, Natural Oak, Beech, Polish Oak, Walnut, White

### 3D Look

- Sonoma Oak, White Ash, Roasted Oak, Oiled Oak, Colombia Light Walnut, Riviera Oak, Gray Oak, Anthracite Oak, Catania Oak

### Iridium

- Snow Ash, Brown Ash, Graphite Ash, Wenge, Marrone Oak

### CPL

- Italian Walnut, Light Acacia, Norwegian Ash, Kendal Oak, Grigio Oak

## EXTRA-COST OPTIONS

- third hinge
- door frame 100'
- door frame 110'

## Installation - remarks:

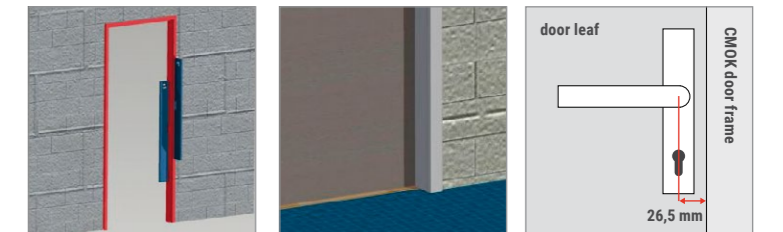

1. Curvature of walls, on which CMOK door frame will be installed.

2. Floors connection point and change in the door leaf position after installing CMOK door frame.

3. Handle and rosette dimensions. Door handle cannot extend beyond the spindle.

## Adjustment insert

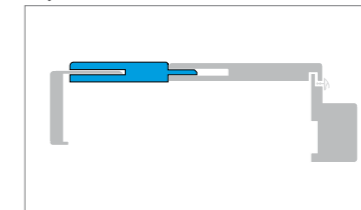

Adjustment insert 75 mm increases the adjustment range:  
 – in the door frame 70-110 mm to 150-185 mm  
 – in the door frame 110-150 mm to 185-220 mm

Dimensions of CMOK door frame [mm]:

	A	B	C	D	E	F
60	574	593	561	723	626	696
70	674	693	661	823	726	796
80	774	793	761	923	826	896
90	874	893	861	1023	926	996
100	974	993	961	1123	1026	1096
110	1074	1093	1061	1223	1126	1196

## Adjustment range [mm]:

70-110
110-150

# Steel door frames

Steel door frames are perfect for apartments and offices, but all their advantages are revealed in public utility buildings and rooms with heavy traffic. All steel door frames can be used in combination with Natura HK/HB (CPL and HPL) technical doors as well as standard lacquered frame and panel doors produced by Classen.

On the following pages you will find adjustable and fixed door frames, each of which is offered in rebated and non-rebated versions.



## STEEL FIXED REBATED / NON-REBATED

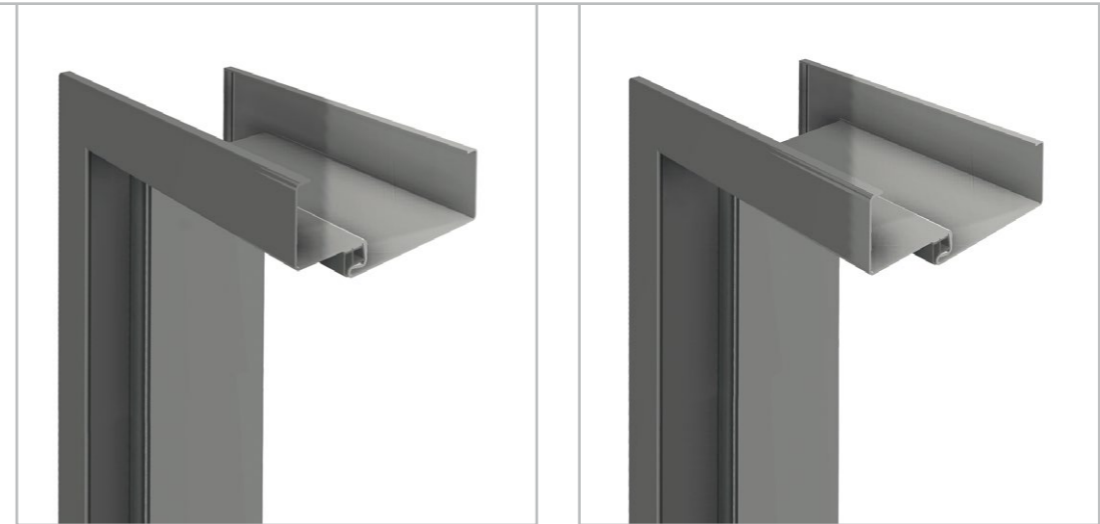

### EXECUTION STANDARD

- made of high quality steel plate, thickness 1.2 mm.
- the full door frame consists of one base element, hinges, gasket and full set of cover caps.
- gaskets available in three colours – White, Gray, Brown.
- two hidden hinges 3D as standard (non-rebated version)
- two hinges as standard; third hinge as non-extra-cost option (rebated version)
- door frame designed for installation in rooms with completed walls and floor
- non-rebated door frame available only in a single leaf version

### COLOURS

- powder coated door frame. RAL colours: White (9003), Gray (7047), Graphite (7024)
- other RAL colours as well as other custom features are subject to individual pricing:
- [inwestycje@classen.com.pl](mailto:inwestycje@classen.com.pl)

### EXTRA-COST OPTIONS

- reinforcement for door closer
- preparation for electric (door) strike
- execution in galvanized steel
- transition threshold
- double leaf door frames
- RAL 7024 colours

### STEEL FIXED REBATED ▼

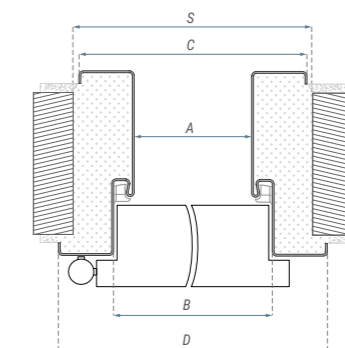
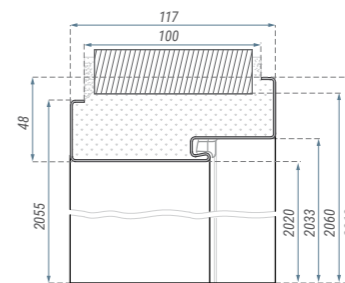
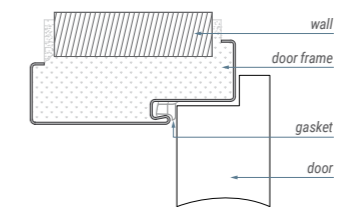

### STEEL FIXED NON-REBATED ▼

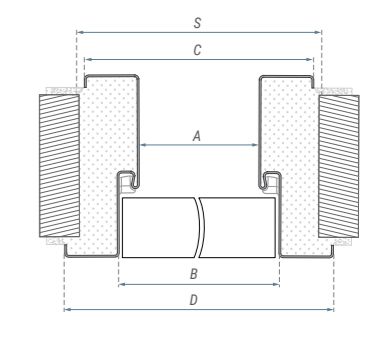
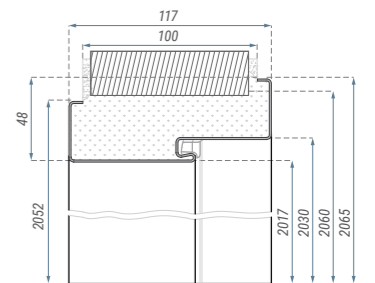
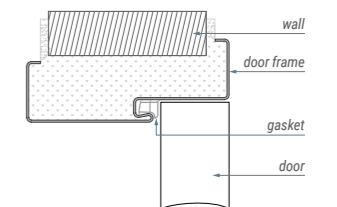

Dimensions of steel fixed and steel fixed non-rebated door frame (single leaf) [mm]:

	A	B	C	D	S		A	B	C	D	S
60	601	627	671	697	685	120	1235	1261	1305	1331	1315
70	701	727	771	797	785	130	1335	1361	1405	1431	1415
80	801	827	871	897	885	140	1435	1461	1505	1531	1515
90	901	927	971	997	985	150	1535	1561	1605	1631	1615
100	1001	1027	1071	1097	1085	160	1635	1661	1705	1731	1715
110	1101	1127	1171	1197	1185	170	1735	1761	1805	1831	1815
120	1201	1227	1271	1297	1285	180	1835	1861	1905	1931	1915
<b>SINGLE LEAF</b>						190	1935	1961	2005	2031	2015
						200	2035	2061	2105	2131	2115

**DOUBLE LEAF**

# STEEL ADJUSTABLE

# STEEL ADJUSTABLE NON-REBATED

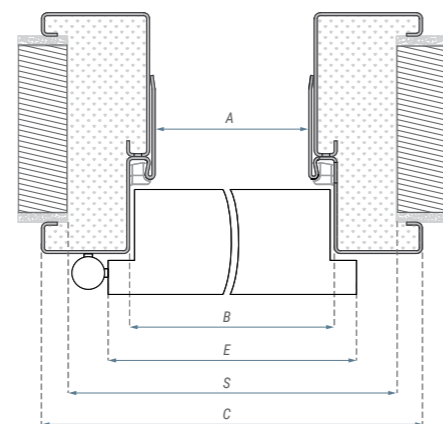
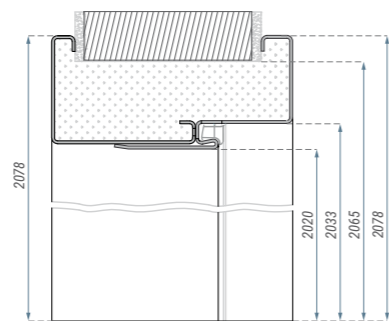
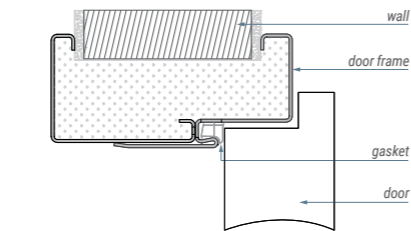

### EXECUTION STANDARD

- Steel Adjustable door frames are designed for installation in different types of rooms with completed walls and floor – flats, public utility building, hotels, etc.
- Durable construction enables application both in masonry walls as well as drywalls.

### Construction:

- made of high quality steel plate, thickness 1.5 mm
- a full door frame consists of a base element, adjusting part, hinges, gasket and full set of cover caps
- gaskets available in three colours – White, Gray, Brown
- two hinges as standard; third hinge as a non-extra-cost option

### COLOURS

- Powder coated door frame. RAL colours: White (9003), Gray (7047), Graphite (7024).
- Other RAL colours as well as other custom features are subject to individual pricing: inwestycje@classen.com.pl

### EXTRA-COST OPTIONS

- reinforcement for door closer
- preparation for electric (door) strike
- execution in galvanized steel
- RAL 7024 colours
- transition threshold
- double leaf door frames

Dimensions of the steel adjustable door frame [mm]:

	A	B	C	E	S		A	B	C	E	S
60	601	627	717	644	685	100	1035	1061	1151	1079	1120
70	701	727	817	744	785	110	1135	1161	1251	1179	1220
80	801	827	917	844	885	120	1235	1261	1351	1279	1320
90	901	927	1017	944	985	130	1335	1361	1451	1379	1420
100	1001	1027	1117	1044	1085	140	1435	1461	1551	1479	1520
110	1101	1127	1217	1144	1085	150	1535	1561	1651	1579	1620
120	1201	1227	1317	1244	1085	160	1635	1661	1751	1679	1720
<b>SINGLE LEAF</b>						170	1735	1761	1851	1779	1820
						180	1835	1861	1951	1879	1920
						190	1935	1961	2051	1979	2020
						200	2035	2061	2151	2079	2120
						<b>DOUBLE LEAF</b>					

Adjustment range [mm]:

95-125	245-275
125-155	275-305
155-185	305-335
185-215	335-365
215-245	

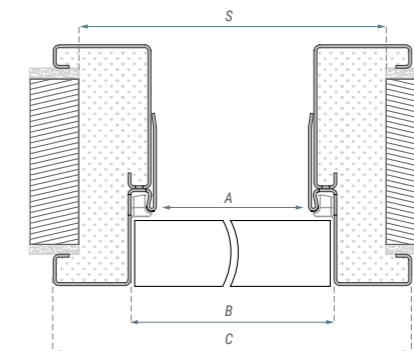
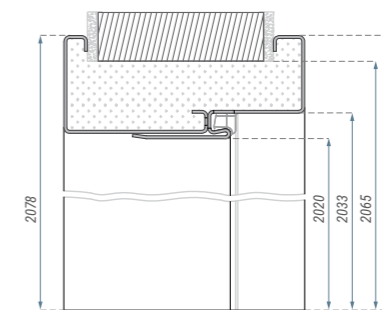
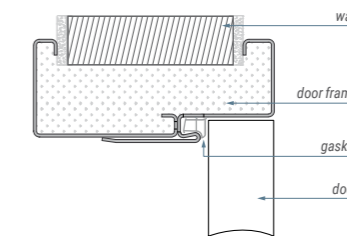

### EXECUTION STANDARD

- made of high quality steel plate, thickness 1.5 mm.
- a full door frame consists of a base element, adjusting part, hinges, gasket and full set of cover caps
- gaskets available in three colours – White, Gray, Brown
- two hidden hinges 3D as standard
- door frame designed for installation in rooms with completed walls and floor
- available only in single leaf version

### COLOURS

- powder coated door frame. RAL colours: White (9003), Gray (7047), Graphite (7024)
- other RAL colours as well as other custom features are subject to individual pricing: inwestycje@classen.com.pl

### EXTRA-COST OPTIONS

- reinforcement for door closer
- preparation for electric (door) strike
- execution in galvanized steel
- RAL 7024 colours
- transition threshold

Dimensions of the adjustable non-rebated steel door frame [mm]:

	A	B	C	S
60	601	627	717	695
70	701	727	817	795
80	801	827	917	895
90	901	927	1017	995
100	1001	1027	1117	1095
110	1101	1127	1217	1195
120	1201	1227	1317	1295

Adjustment range [mm]:

110-140	260-290
140-170	290-320
170-200	320-350
200-230	350-380
230-260	

# Dedicated door frames

Specialized technical doors require appropriately selected door frames. For example, fire doors do not meet their standards and are ineffective without a matching frame with fire-resistant properties.

In this section you will find frames matching Classen technical doors, such as Bord, Bord W3, acoustic and fire doors.



## BORD STEEL FIXED / CORNER FIXED



### EXECUTION STANDARD

- steel plate thickness 1.2 mm
- openings for top and bottom deadbolt lock (B – for steel fixed Bord door frame and steel fixed corner Bord door frame) or multipoint lock openings (W – only for steel fixed Bord door frame)
- openings for interlocking door bolts for W1 (for steel fixed Bord door frame and steel fixed corner Bord door frame) and W2 (only for steel fixed Bord door frame) door leaf versions.
- reinforcement for door closer
- single leaf 80'-100'

### COLOURS

- powder coated door frame. RAL colours: White (9016), Gray (7047), Brown (8017), White (9003), Graphite (7024)
- other RAL colours as well as other custom features are subject to individual pricing: [inwestycje@classen.com.pl](mailto:inwestycje@classen.com.pl)

### EXTRA-COST OPTIONS

- dimension 100'
- RAL 7024 colours
- transition threshold

### BORD STEEL FIXED ▼

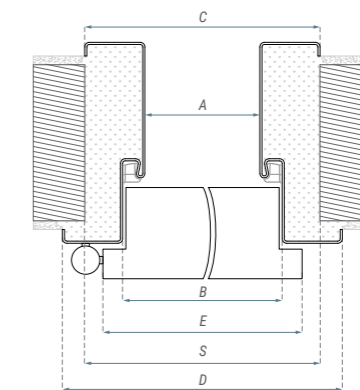
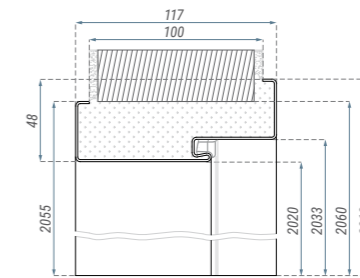
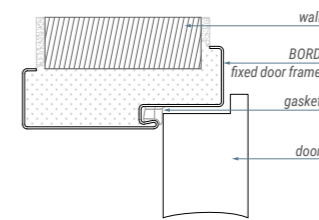

### BORD STEEL CORNER FIXED ▼

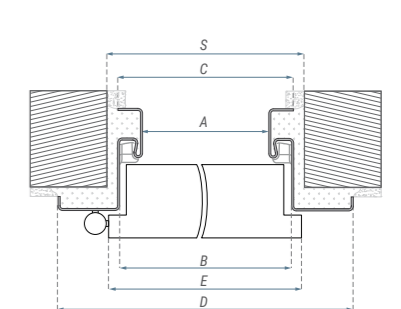
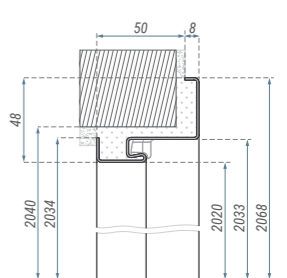
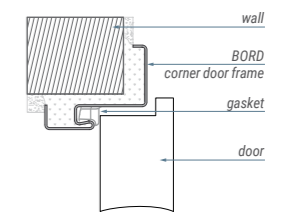

Dimensions of BORD fixed door frame [mm]:

	A	B	C	D	E	S
80	801	827	871	897	744	875
90	901	927	971	997	844	975
100	1001	1027	1071	1097	944	1075

Dimensions of BORD corner fixed door frame [mm]:

	A	B	C	D	E	S
80	801	827	829	897	844	865
90	901	927	929	997	944	965
100	1001	1027	1029	1097	1044	1065

## BORD MDF FIXED

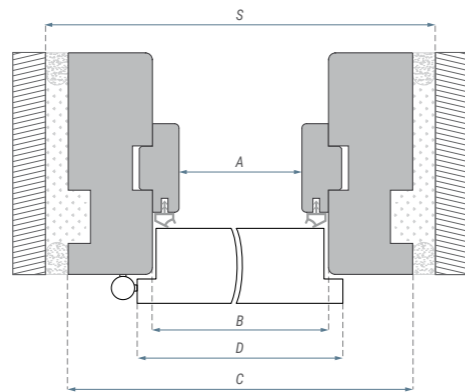
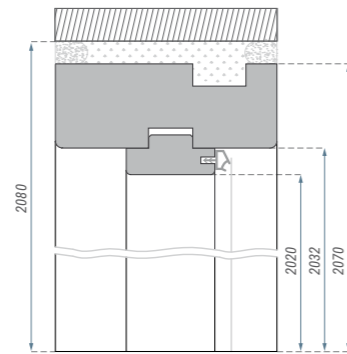
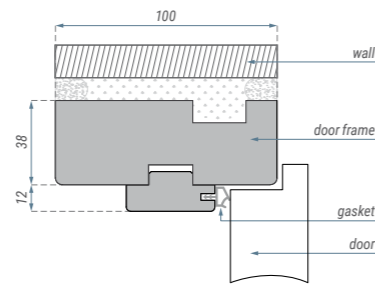

Dimensions of BORD MDF door frame [mm]:

	A	B	C	D	S
80	802	826	902	844	925
90	902	926	1002	944	1025
100	1002	1026	1102	1044	1125



**Fixed, wooden threshold with a gasket**  
100 cm long threshold – for shortening by the buyer.  
Hardwood, protected by clear lacquer.

### EXECUTION STANDARD

- this door frame is designed for internal entrance door leaves. It is made of MDF board, veneered with Classen decors
- surface finishing: Primo, Iridium, 3D Look, CPL
- bolt lock striking plate top and bottom (B) or multipoint lock striking plate (W)
- version W2 includes sleeves for interlocking door bolts
- single leaf 80'-100'

### COLOURS

#### Primo

- Acacia ST, White, Natural Oak, Beech, Polish Oak, Walnut

#### 3D Look

- Oiled Oak, Roasted Oak, White Ash, Colombia Light Walnut, Sonoma Oak, Riviera Oak, Gray Oak, Anthracite Oak

#### Iridium

- Marrone Oak, Snow Ash, Brown Ash, Graphite Ash, Wenge

#### CPL

- Italian Walnut, Light Acacia, White (RAL 9003), Gray (RAL 7047), Graphite (RAL 7024), Norwegian Ash, Kendal Oak, Grigio Oak, White with horizontal structure

### EXTRA-COST OPTIONS

- dimension 100'
- fixed, wooden threshold (16 x 79 mm)
- fixed, wooden threshold (20 x 100 mm)

## HYBRID

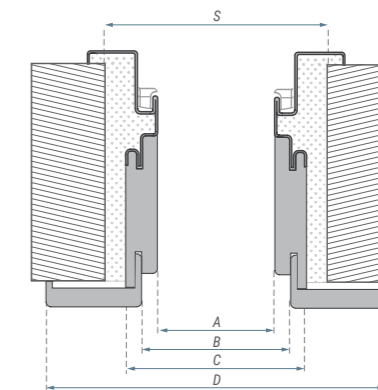
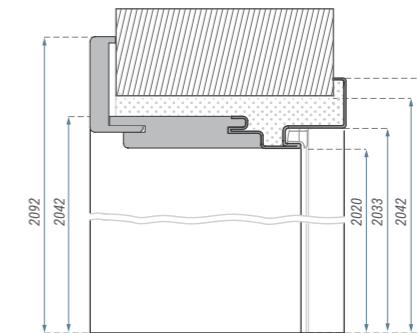
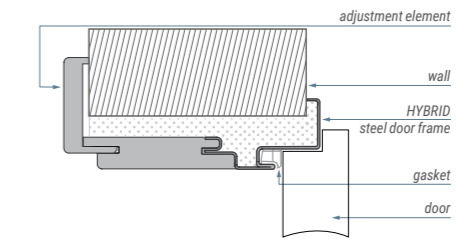

### EXECUTION STANDARD

- Hybryda door frame is designed for BORD B, W and W3 internal entrance door leaves. A complete door frame consists of Hybryda steel door frame and an adjustment element.
- When installed, they create one whole. Depending on the direction of opening the door, the adjustment element may relate to the colour of the joinery inside the flat or be a decoration of the staircase.

### Packaging:

- Hybryda door frame and adjustment element are packed in two separate packages.

### ADJUSTMENT ELEMENT COLOURS

#### Iridium

- Snow Ash, Brown Ash, Graphite Ash, Wenge

#### CPL

- Light Acacia, Norwegian Ash, Italian Walnut, White (RAL 9003), Gray (RAL 7047), Graphite (RAL 7024), Grigio Oak, Kendal Oak

### STEEL ELEMENT COLOURS

#### Malowany proszkowo

- RAL colours: White (9003), Gray (7047), Graphite (7024)

### EXTRA-COST OPTIONS

- RAL 7024 colour
- transition threshold

Dimensions of Hybryda door frame [mm]: Adjustment range [mm]:

	A	B	C	D	S	140-180	220-260
80	804	826	848	949	875	180-220	260-300
90	904	926	948	1049	975		
100	1004	1026	1048	1149	1075		

## BORD W3 STEEL FIXED

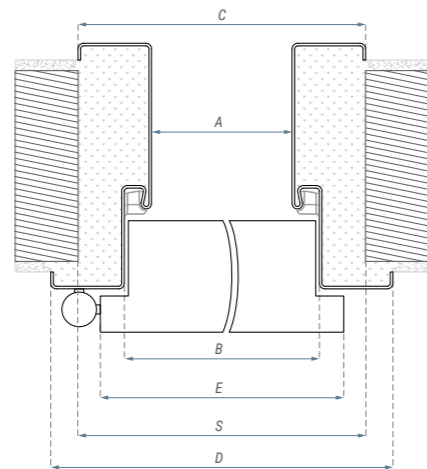
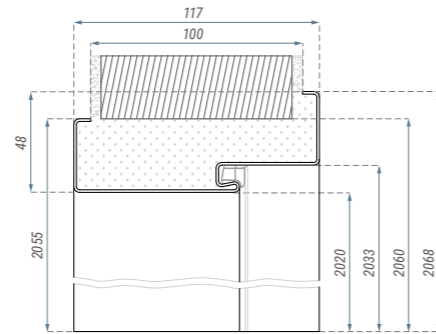
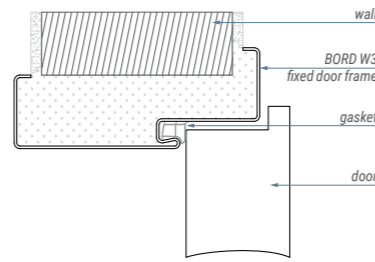

### EXECUTION STANDARD

- steel plate thickness 1.5 mm;
- complete door frame includes gasket, 3 hinges and full set of cover caps
- gaskets available in three colours – White, Gray, Brown
- openings for multipoint lock (W)
- openings for interlocking door bolts
- reinforcement for door closer
- single leaf 80'-100'

### COLOURS

- powder coated door frame. RAL colours: Gray (7047), White (9003), Graphite (7024)
- other RAL colours as well as other custom features are subject to individual pricing: [inwestycje@classen.com.pl](mailto:inwestycje@classen.com.pl)

### EXTRA-COST OPTIONS

- dimension 100'
- RAL 7024 colours
- transition threshold

Dimensions of BORD W3 fixed door frame [mm]:

	A	B	C	D	E	S
80	801	827	871	897	844	885
90	901	927	971	997	944	985
100	1001	1027	1071	1097	1044	1085

## GUARD STEEL FIXED / ADJUSTABLE



### EXECUTION STANDARD

- made of high quality steel plate, thickness 1.5 mm.
- complete door frame includes gasket, hinges and full set of cover caps.
- gaskets available in three colors: White, Gray, Brown
- 3 silver three-wing hinges constitute a complete set (door + door frame)

### COLOURS

- powder coated door frame. RAL colours: White (9003), Gray (7047), Graphite (7024)
- other RAL colours as well as other custom features are subject to individual pricing: [inwestycje@classen.com.pl](mailto:inwestycje@classen.com.pl)

### EXTRA-COST OPTIONS

- RAL 7024 finish
- dimension 100'
- dimension 110'
- transition threshold

### GUARD STEEL FIXED

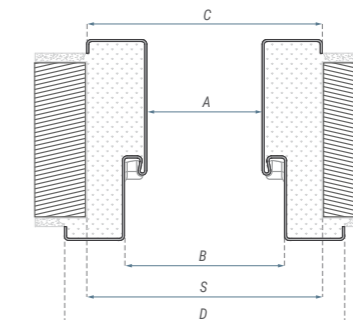
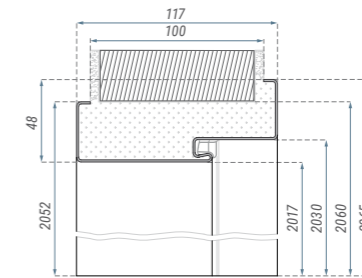
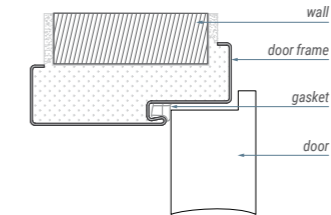

### GUARD STEEL ADJUSTABLE

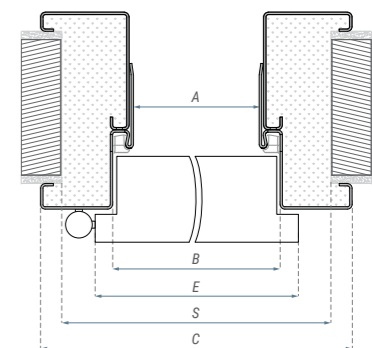
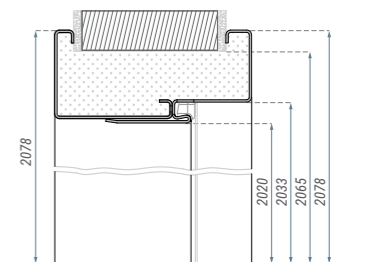
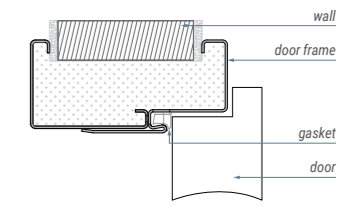

Dimensions of GUARD fixed door frame [mm]:

	A	B	C	D	S
70	701	727	771	797	785
80	801	827	871	897	885
90	901	927	971	997	985
100	1001	1027	1071	1097	1085
110	1101	1127	1171	1197	1185

Dimensions of GUARD Adjustable door frame [mm]:

	A	B	C	D	S
70	701	727	817	797	785
80	801	827	917	897	885
90	901	927	1017	997	985
100	1001	1027	1117	1097	1085
110	1101	1127	1217	1197	1185

## FIRE WOODEN FIXED / STEEL FIXED



### EXECUTION STANDARD - FIRE WOODEN

- FIRE wooden fixed door frame 100 mm is made of wood, veneered with Iridium decors and CPL laminates
- a complete door frame includes four hinges and a gasket
- EI30 W1/W2 version does not include expanding seals
- EI60 W1/W2 version includes expanding seal
- available dimensions – 60', 70', 80', 90', 91', 100', 101', 110'
- double leaf door frames and other custom features are subject to individual pricing: [inwestycje@classen.com.pl](mailto:inwestycje@classen.com.pl)

### EXECUTION STANDARD - FIRE STEEL

- FIRE steel fixed door frame is made of steel plate of thickness 1.5 mm, powder-coated in RAL colours: White (9016), Gray (7047), Brown (8017), White (9003), Graphite (7024)
- complete door frame includes four hinges and a fire-resistant gasket
- gaskets available in three colours – White, Gray, Brown
- reinforcement for door closer
- available dimensions – 80', 90', 91', 100', 101', 110'
- EI60 double leaf door frames, other RAL colours as well as other custom features are subject to individual pricing: [inwestycje@classen.com.pl](mailto:inwestycje@classen.com.pl)

FIRE WOODEN FIXED ▼

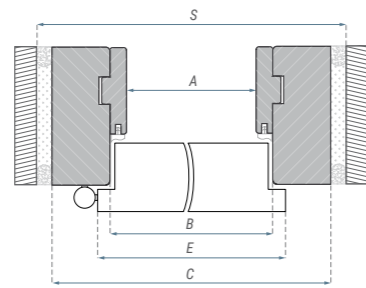
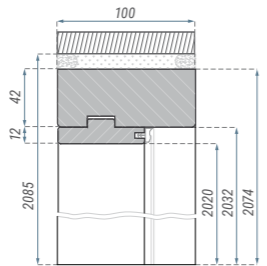
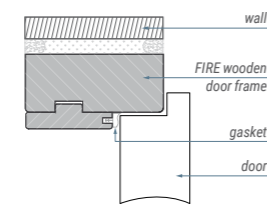

FIRE STEEL FIXED ▼

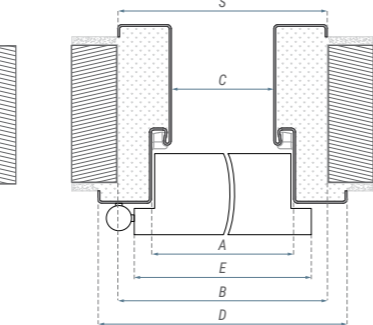
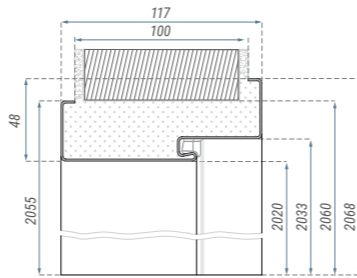
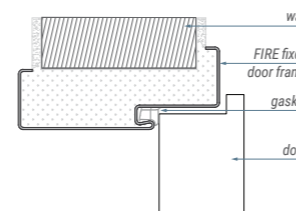

Dimensions of FIRE fixed door frame [mm]:

	A	B	C	D	E	S
<b>80</b>	800	826	870	896	844	870
<b>90</b>	900	926	970	996	944	970
<b>91</b>	912	938	970	996	944	970
<b>100</b>	1000	1026	1070	1096	1044	1070
<b>101</b>	1012	1038	1070	1096	1044	1070
<b>110</b>	1100	1126	1170	1196	1144	1170
<b>100</b>	1035	1061	1105	1131	1079	1105
<b>110</b>	1135	1161	1205	1231	1179	1205
<b>120</b>	1235	1261	1305	1331	1279	1305
<b>130</b>	1335	1361	1405	1431	1379	1405
<b>140</b>	1435	1461	1505	1531	1479	1505
<b>150</b>	1535	1561	1605	1631	1579	1605
<b>160</b>	1635	1661	1705	1731	1679	1705
<b>170</b>	1735	1761	1805	1831	1779	1805
<b>180</b>	1835	1861	1905	1931	1879	1905
<b>190</b>	1935	1961	2005	2031	1979	2005
<b>200</b>	2035	2061	2105	2131	2079	2105

Dimensions of FIRE wooden door frame [mm]:

	A	B	C	E	S
<b>80</b>	802	826	910	844	930
<b>90</b>	902	926	1010	944	1030
<b>91</b>	914	938	1010	944	1030
<b>100</b>	1002	1026	1110	1044	1130
<b>101</b>	1014	1038	1110	1044	1130
<b>110</b>	1102	1126	1210	1144	1230
<b>100</b>	1040	1064	1148	1079	1170
<b>110</b>	1140	1164	1248	1179	1270
<b>120</b>	1240	1264	1348	1279	1370
<b>130</b>	1340	1364	1448	1379	1470
<b>140</b>	1440	1464	1548	1479	1570
<b>150</b>	1540	1564	1648	1579	1670
<b>160</b>	1640	1664	1748	1679	1770
<b>170</b>	1740	1764	1848	1779	1870
<b>180</b>	1840	1864	1948	1879	1970
<b>190</b>	1940	1964	2048	1979	2070
<b>200</b>	2040	2064	2148	2079	2170

## 42 DB MFD FIXED NON-REBATED / REBATED



### EXECUTION STANDARD - 42 DB MDF FIXED

- This door frame is designed for internal entrance rebated fire door leaves: EI30 42dB and acoustic 42dB. Door frame is made MDF board, covered with Iridium decors and CPL laminates.
- Available in dimensions 60'-90'. Complete door frame includes four hinges and a gasket.

### EXECUTION STANDARD - 42 DB MDF FIXED NON-REBATED

- Door frame is designed for internal non-rebated fire EI30 42dB and acoustic 42db door leaves. Door frame is made MDF board, covered with Iridium decors and CPL laminates.
- Available in dimensions 60'-90'. Complete door frame includes four hidden hinges and a double set of gaskets. Milling for hidden self-closer (non-extra-cost option).

42 DB FIXED REBATED ▼

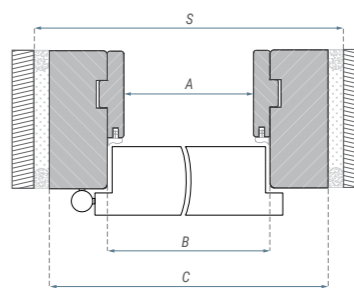
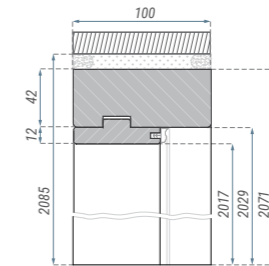
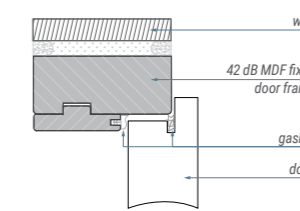

42 DB FIXED NON-REBATED ▼

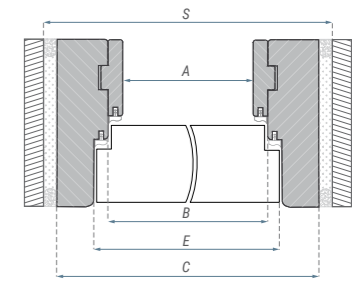
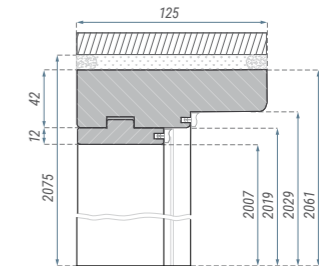
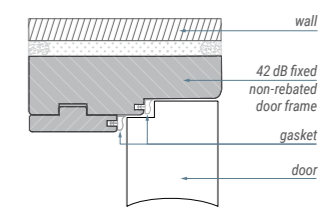

Fixed door frame dimensions MDF 42dB [mm]

	A	B	C	S
<b>60</b>	600	624	708	738
<b>70</b>	700	724	808	838
<b>80</b>	800	824	908	938
<b>90</b>	900	924	1008	1038

Fixed non-rebated door frame dimensions MDF 42dB [mm]

	A	B	C	E	S
<b>60</b>	638	662	750	686	780
<b>70</b>	738	762	850	786	880
<b>80</b>	838	862	950	886	980
<b>90</b>	938	962	1050	986	1080

CORE



HONEYCOMB filling



PERFORATED CHIPBOARD filling



CLASSEN HARD reinforced construction



CLASSEN HARD EDGE PF construction for PF rebate

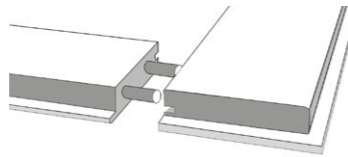

FRAME CONSTRUCTION construction elements connected with mounting pins

REBATED DOOR LEAVES PROFILES



K PROFILE



R PROFILE



PF PROFILE postforming

VENTILATION



PASS-THROUGH VENTILATION SLEEVES Single-coloured PVC, matching door decors



METAL VENTILATION SLEEVES satine chrome



PASS-THROUGH VENTILATION GRILLE made of plastic, matching door decors



VENTILATION UNDERCUT IN PANEL DOORS\* undercut 15 mm - for rooms with recuperation undercut 26 mm - WC for doors 80'-100' undercut 38 mm - WC for doors 60'-70'

60'-100'

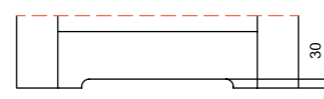

HEIGHT OF VENTILATION UNDERCUT IN FRAME DOORS, FOR WIDTH 60'-100' \*\*)

\* | In line with applicable rules, ventilation area in the door leaf cannot be less than 0,022 m<sup>2</sup> for air flow. These requirements are fulfilled by ventilation grille and ventilation undercut. Not applicable to Andromeda and Salvano collections, for dimensions 60' and 70'. Undercut 15 mm – for rooms with recuperation, undercut 30 mm WC for doors.

\*\* | In frame doors with a width of 60', 70', ventilation undercut does not meet the required air throughput in accordance with applicable regulations.

TYPE OF DOOR REBATE

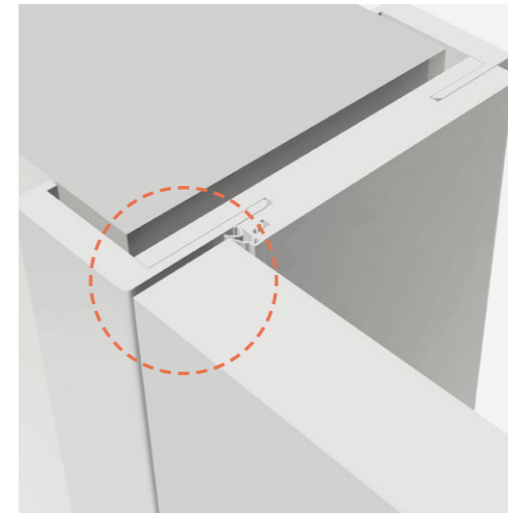

NON-REBATED DOOR

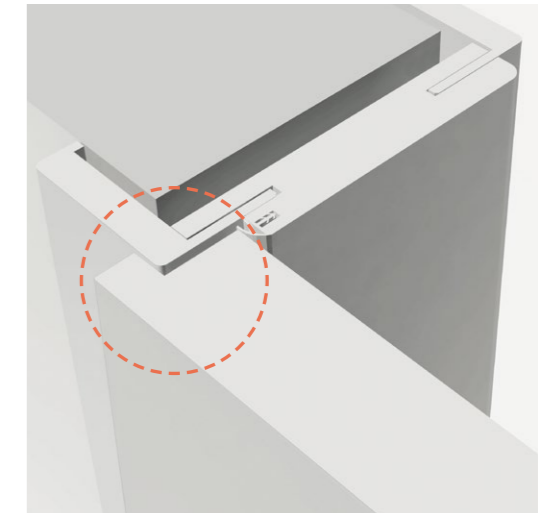

REBATED DOOR



3D HINGE



STRIKE PLATE



STRIKE PLATE



HINGE

DOOR OPENING DIRECTION

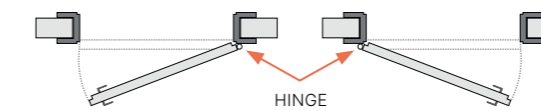

SINGLE LEAF DOOR, RIGHT

SINGLE LEAF DOOR, LEFT



SLIDING DOOR, RIGHT

SLIDING DOOR, LEFT

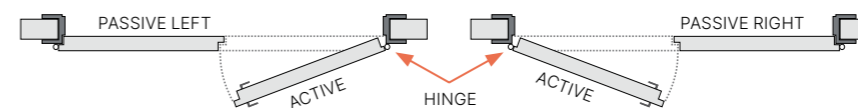
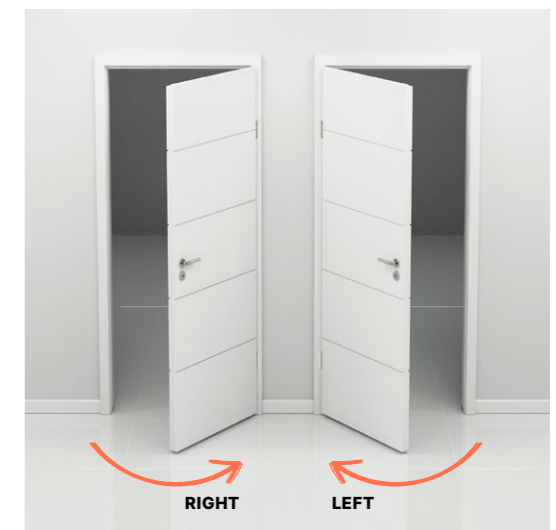

DOUBLE LEAF DOOR, RIGHT

DOUBLE LEAF DOOR, LEFT



# ADDITIONAL ELEMENTS



STEEL KICK-PLATE, SOLID  
one-sided or two-sided



STEEL KICK-PLATE WITH VENTILATION GRILLE  
two-sided



STEEL PUSH-PLATE  
one-sided or two-sided



ALUMINUM VENTILATION GRILLE  
two-sided



PORTHOLE  
internal diameter – 240 mm, milky-white or transparent glass

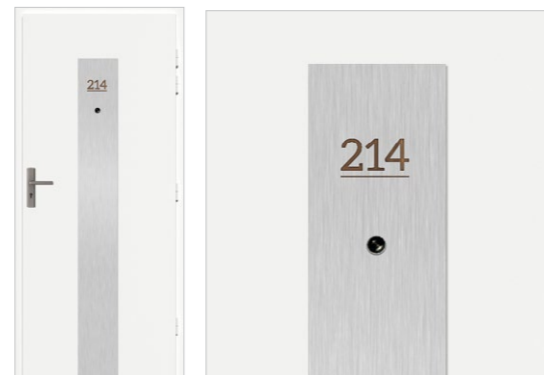

STEEL VERTICAL PUSH-PLATE  
with any room number

# DOOR DIMENSIONS

## REBATED DOOR LEAVES DIMENSIONS

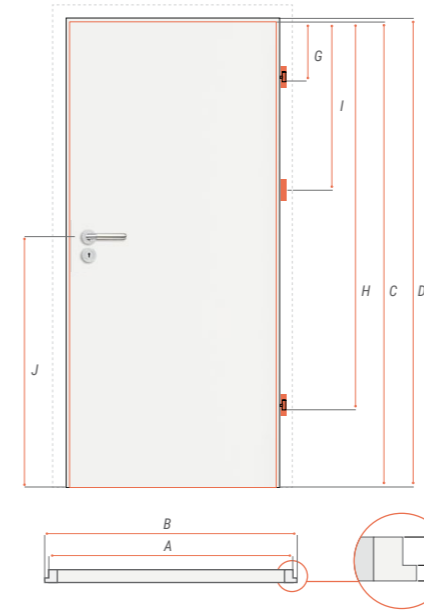

door leaf width	A	B
60	618	644
70	718	744
80	818	844
90	918	944
100	1018	1044
110	1118	1144
120	1218	1244
120	1253	1279
130	1353	1379
140	1453	1479
150	1553	1579
160	1653	1679
170	1753	1779
180	1853	1879
190	1953	1979
200	2053	2079

	dimension (mm)
C	2022
D	2035
E	26
F	13
G	239
H	1717
I	777
J	1112

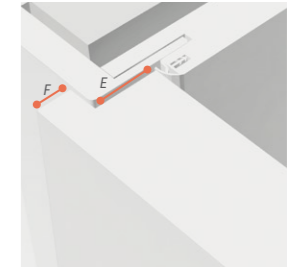

## NON-REBATED DOOR LEAVES DIMENSIONS

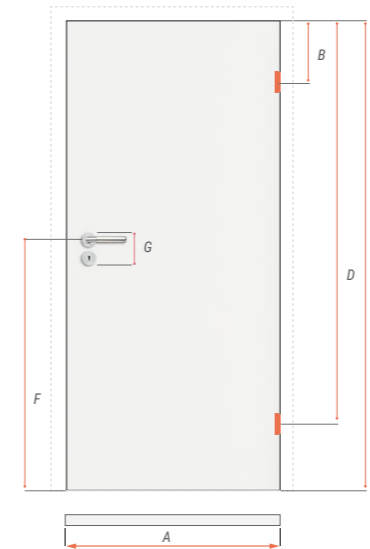

door leaf width	A (mm)
60	618
70	718
80	818
90	918
100	1018

	dimension (mm)
B	275
D	1717
E	2022
F	1112
G	85 – cylinder 90 – wc 90 – mortice key



## SLIDING DOOR LEAVES DIMENSIONS

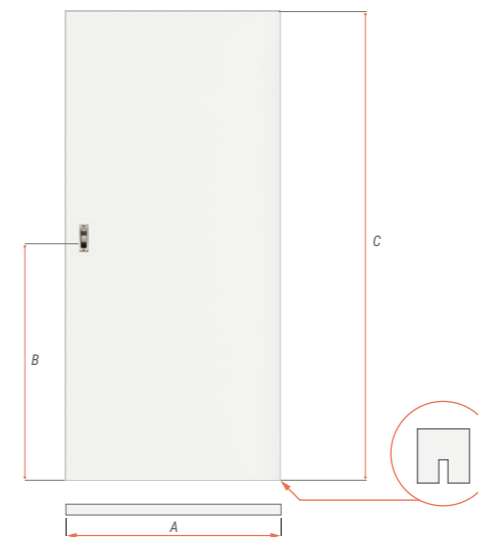

	dimension (mm)
A	644, 744, 844, 944, 1044
B	977
C	2035

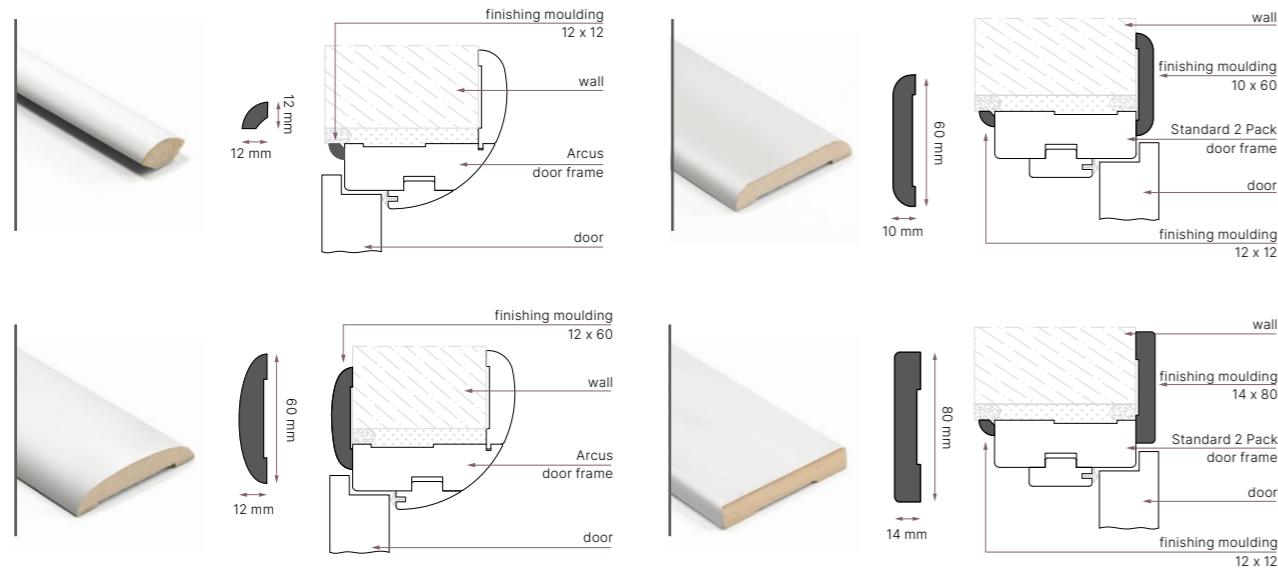

14X80 MM AS FINISHING MOULDING FOR DOORS AND AS WALL BASE MOULDING



**Application:**  
Finishing mouldings are used for masking non-finished places of joining the walls and a door frame. 14x80 moulding can be also installed as a wall base moulding. It is possible to instal finishing mouldings with small nails.

**Colours:**  
Available in all door decors and white lacquer.

**Packaging:**  
One package contains three finishing mouldings to be cut to match single or double leaf doors.

For single leaf door:  
2x vertical element 2160 mm, 1x beam 1160 mm.

For double leaf door:  
2x vertical element 2160 mm, 1x beam 2350 mm.

ADJUSTMENT BAND WITH TONGUE 60 MM



**APPLICATION**  
The band is an optional element designed for adjustable and adjustable 80 door frame\*.

The band with longer tongue increases the adjustment range by 17 mm. Available in the following width: 60'-90'.

**EXTRA-COST OPTIONS**  
width 100'

Table, door and frames RAL colour groups \*\*)

Group	Color number
I	1013 1014 1015 7004 7032 7035 7038 7040 7044 7047 9001 9002 9010 9016
II	1000 1001 1002 1011 1019 1020 1024 3009 3012 3015 3034 5012 5014 5015 5018 6021 6027 6034 7000 7002 7003 7005 7006 7009 7023 7030 7031 7034 7036 7037 7039 7042 7045 7046 8002 8017 8024 8025 9011
III	1003 1004 1005 1012 1017 1034 3000 3014 3017 3018 3022 4001 4002 4003 4005 4006 4008 4009 4010 5000 5001 5002 5003 5005 5007 5008 5009 5011 5013 5017 5019 5020 5021 5022 5023 6000 6003 6006 6008 6010 6011 6012 6014 6015 6016 6017 6020 6022 6024 6026 6028 6032 6033 7008 7013 7024 7026 8000 8001 8003 8004 8007 8008 8011 8014 8019 8022 8023 9005 9017
IV	1006 1007 1016 1018 1021 1023 1027 1028 1032 1033 2000 2001 2002 2003 2008 2009 2010 2011 2012 3001 3002 3003 3004 3005 3007 3011 3013 3016 3020 3027 3031 4004 4007 5004 6001 6002 6004 6007 6009 6018 6025 7016 8012

CROWN

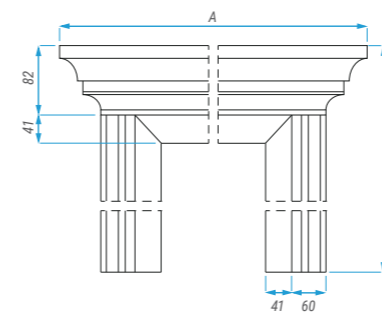

CROWN I

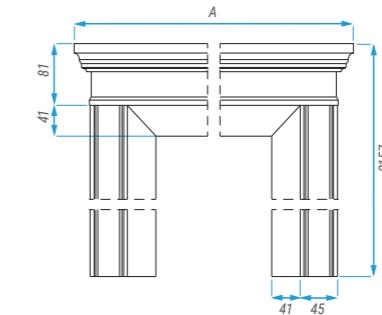

MOULDING II - LN2

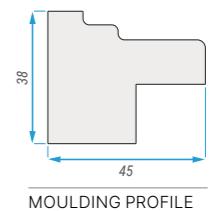
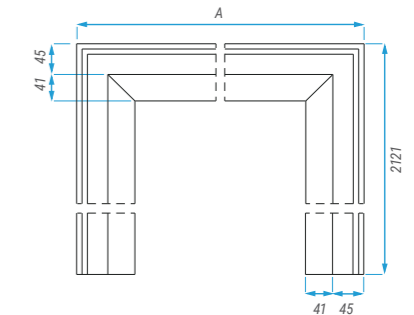

CROWN AND MOULDING

Crowns and a moulding are designed for installation with Adjustable and Adjustable Non-rebated door frame (single leaf). Not available with band 80. Crowns are not adjusted for installation on a door leaf with a band 80 mm. Surface finishing: PU lacquered.

Lacquer from RAL palette as an extra-cost option. Minimum order quantity – 3 sets, door leaf + door frame + crown.

Adjustable door frame	dimension A (mm)		
	Crown	Crown I	Moulding LN2
60	900	843	800
70	1000	943	900
80	1100	1043	1000
90	1200	1143	1100
100	1300	1243	1200

Table of optional finishes in RAL colours on page 146.

\* | Available in decors as for the non-rebated adjustable 80 door frame (details on page 125).  
\*\* | Minimum order quantity in the case of RAL colour finish - 3 sets (door leaf + door frame).

## VENTILATION

PVC VENTILATION SLEEVES MATCHING THE COLOUR OF THE DOOR LEAF VENEER:



WHITE LIGHT GRAY LIGHT BEIGE DARK BEIGE BROWN DARK BROWN GRAPHITE



ALUMINUM GRILLE  
for technical doors

## VENTILATION GRILLES

MADE OF PLASTIC, MATCHING THE COLOUR OF THE DOOR LEAF VENEER



WHITE LIGHT BEIGE DARK BEIGE GRAY ORANGE DARK BROWN GRAPHITE

## LOCKS



REBATED DOOR LEAVES LOCK  
left and right version  
mortice key lock / cylinder lock / WC (4x4)



MAGNETIC LOCK  
for non-rebated doors  
mortice key lock / cylinder lock / WC (6x6)



HOOK LOCK  
for sliding doors  
mortice key lock / WC lock



DEADBOLT LOCK  
bottom, Bord  
left / right



DEADBOLT LOCK  
top Bord



FIRE LOCK



CYLINDER LOCK  
Designed for cylinder locks,  
26/36 mm



SET OF CYLINDER LOCKS  
Designed for cylinder locks,  
26x40 class II (BORD W3)

## HINGES



3D HINGE for non-rebated doors DOOR FRAME HINGE PANEL DOOR HINGE FIRE HINGE wooden door frame FIRE HINGE / GUARD steel door frame

## DOOR STOPS / PEEPHOLES



WALL DOOR STOP nickel cone WALL DOOR STOP nickel square FLOOR DOOR STOP nickel spherical FLOOR DOOR STOP bronze spherical PEEPHOLE nickel PEEPHOLE grafiatto bronze

## PCV PULL HANDLES

ROUND - FOR SLIDING DOORS



WHITE SILVER GOLDEN BEIGE BROWN

## DOOR CLOSERS



DC140 SURFACE MOUNTED DOOR CLOSER  
with standard arm for FIRE door



DC135 DOOR CLOSER  
with sliding rail for FIRE door



DOOR CLOSER  
for sliding doors system

## OTHER ACCESSORIES

NEW!



DOOR PULL HANDLE  
for sliding doors, black



DOOR PULL HANDLE  
for sliding doors, steel



HINGE PVC COVERS  
for panel doors, diameters: 13.5 mm.  
Colours: chrome, satin chrome

# HANDLES

**NEW!**

**TIPO QR**  
black



HANDLE  
with a short escutcheon plate



standard rosette



cylinder rosette



WC rosette

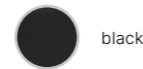

black

**NEW!**

**TIPO QR**  
nickel



HANDLE  
with a short escutcheon plate



standard rosette



cylinder rosette



WC rosette

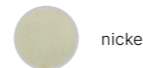

nickel

**NEW!**

**NOVA R**  
brass



HANDLE  
with a short escutcheon plate



standard rosette



cylinder rosette



WC rosette

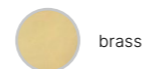

brass

**NEW!**

**NOVA R**  
nickel



HANDLE  
with a short escutcheon plate



standard rosette



cylinder rosette



WC rosette

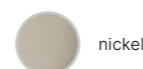

nickel

**DIANA QR**

satin chrome



HANDLE  
with a short escutcheon plate



standard rosette



cylinder rosette



WC rosette

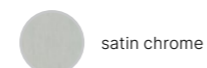

satin chrome

# HANDLES

**FIRE DOOR HANDLE**

stainless steel



HANDLE  
with a short escutcheon plate



standard rosette



cylinder rosette



WC rosette



stainless steel

**ROMANA**

grafiato bronze  
chrome / nickel



HANDLE  
with a short escutcheon plate



standard rosette



cylinder rosette



WC rosette

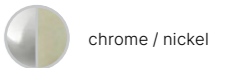

chrome / nickel

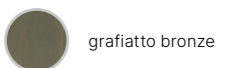

grafiato bronze

**PRADO**

stainless steel,  
satin



HANDLE  
with a short escutcheon plate



standard rosette



cylinder rosette



WC rosette

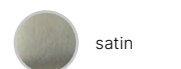

satin

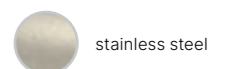

stainless steel

**MINIMAL RT / VALID WHILE STOCK LASTS**

nickel



HANDLE  
with a short escutcheon plate



standard rosette



cylinder rosette



WC rosette

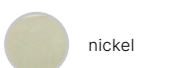

nickel

**POLARIS / VALID WHILE STOCK LASTS**

chrome, white insert



HANDLE  
with a short escutcheon plate



standard rosette



cylinder rosette



WC rosette

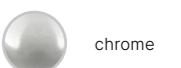

chrome

# HANDLES

**QUBIK QR**  
black matt,  
nickel,  
titanium



HANDLE  
with a short escutcheon plate



standard rosette



cylinder rosette



WC rosette

- NEW!**  
black matt
- nickel
- titanium

**JANE QR**  
nickel



HANDLE  
with a short escutcheon plate



standard rosette



cylinder rosette



WC rosette

- nickel

**SIGMA QR**  
stainless steel,  
satin



HANDLE  
with a short escutcheon plate



standard rosette



cylinder rosette



WC rosette

- satin
- stainless steel

**PALERMO QR**  
nickel



HANDLE  
with a short escutcheon plate



standard rosette



cylinder rosette



WC rosette

- nickel

**FOKUS QR**  
black,  
titanium



HANDLE  
with a short escutcheon plate



standard rosette



cylinder rosette



WC rosette

- NEW!**  
black
- titanium

# HANDLES

**NEW!**  
**NOVA**  
nickel



HANDLE  
with a long escutcheon plate



standard rosette



cylinder rosette



WC rosette

- nickel

**NEW!**  
**NOVAR**  
brass



HANDLE  
with a long escutcheon plate



standard rosette



cylinder rosette



WC rosette

- brass

**ALMAECO**  
grafiato bronze,  
nickel



HANDLE  
with a long escutcheon plate



standard rosette



cylinder rosette



WC rosette

- grafiato bronze
- nickel

**NEW!**  
**SHARK**  
black,  
inox



HANDLE  
with a long escutcheon plate,  
spacing 72 mm, upper rosette, short.  
For W46 Bord door (multipoint lock)  
and FIRE door.



HANDLE  
with a long escutcheon plate,  
spacing 90 mm, upper rosette, long.  
For B40, B46 Bord door  
(deadbolt lock).

- inox
- black

**NEW!**  
**DIVA class III**  
inox



HANDLE  
with a long escutcheon  
plate, spacing 72 mm,  
upper rosette, short.  
For W3 Bord door.



rosette for  
upper lock



long escutcheon for  
cylinder lock

- inox

# VENEER / LACQUER

# VENEER

## PRIMO

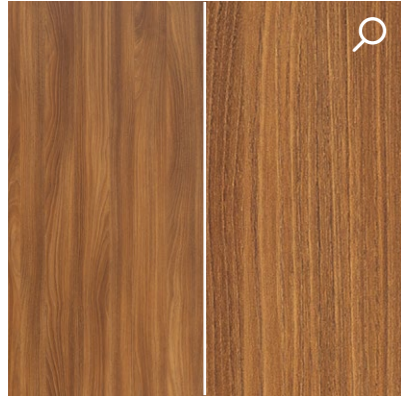

ACACIA ST

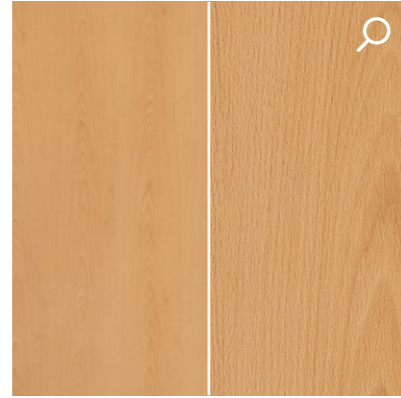

BEECH

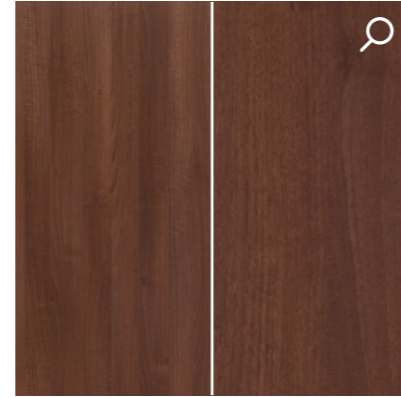

WALNUT

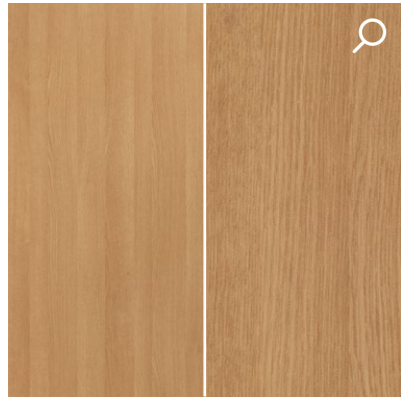

POLISH OAK

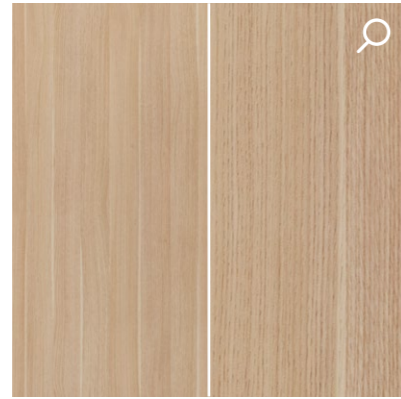

NATURAL OAK

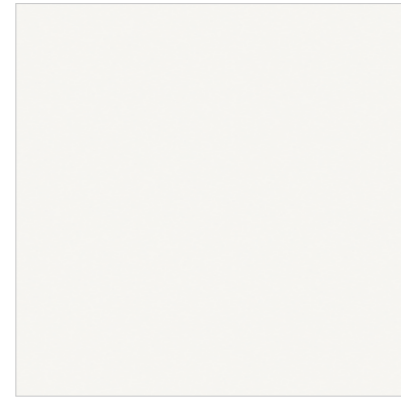

WHITE

## LACQUER

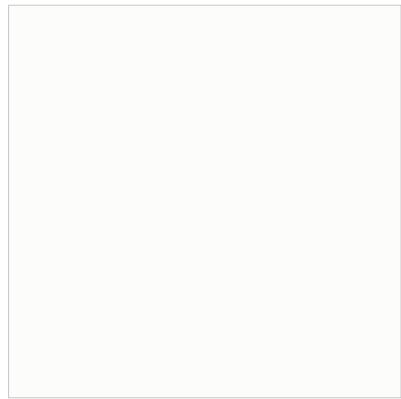

WHITE - LACQUERED, SIMILAR TO RAL 9003



WHITE - LACQUERED WITH STRUCTURE



BLACK - LACQUERED, SIMILAR TO RAL 9005



GRAY - LACQUERED, SIMILAR TO RAL 7004

## 3DLOOK



RIVIERA OAK



ANTHRACITE OAK

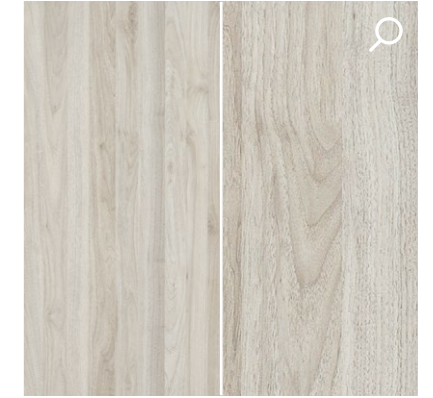

COLOMBIA LIGHT WALNUT

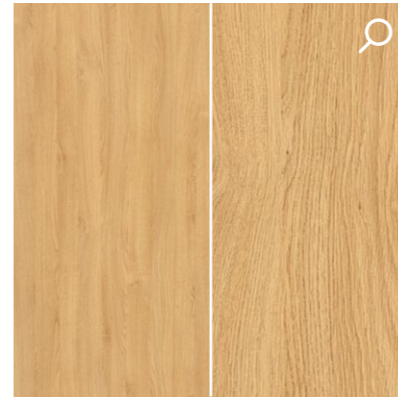

OILED OAK

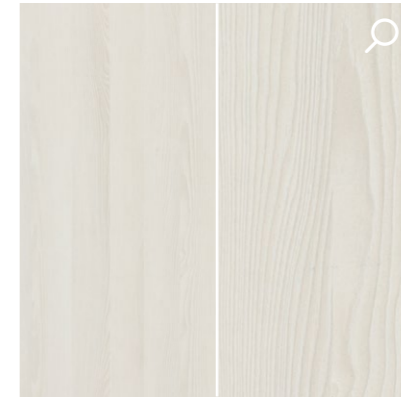

WHITE ASH

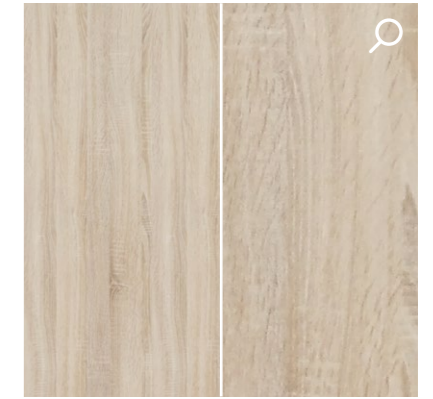

SONOMA OAK

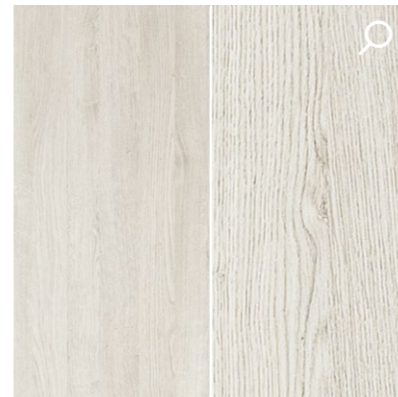

GRAY OAK

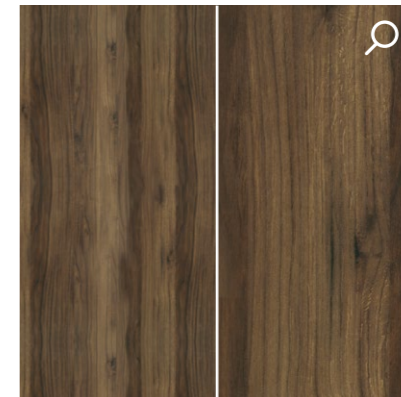

CATANIA OAK

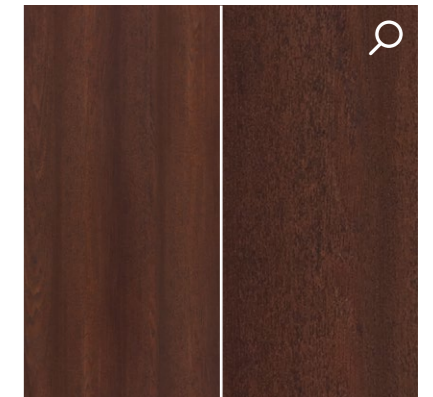

BURNT OAK

# VENEER

# VENEER

## IRIDIUM

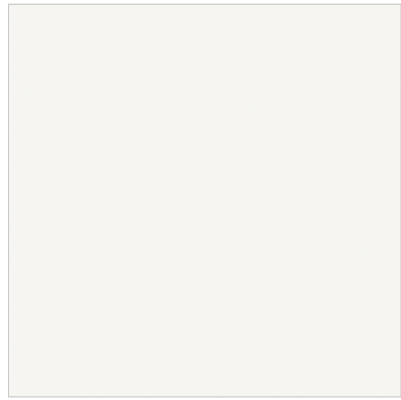

WHITE MATT



GRAY MATT

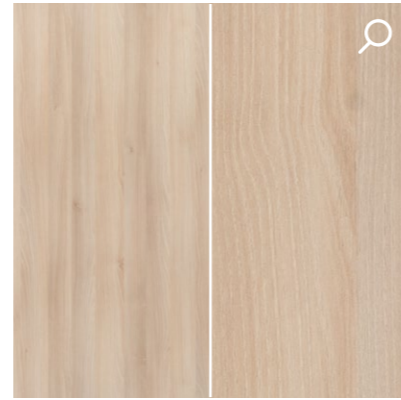

SNOW ASH

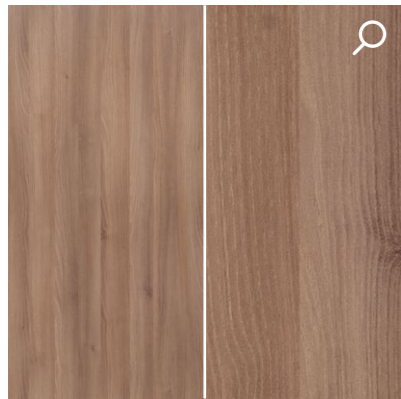

BROWN ASH

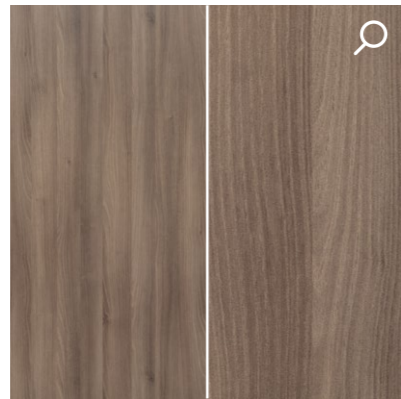

GRAPHITE ASH

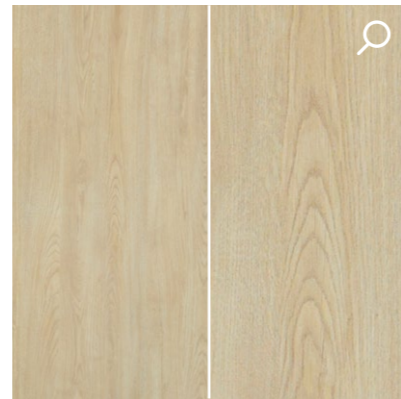

MARONE OAK

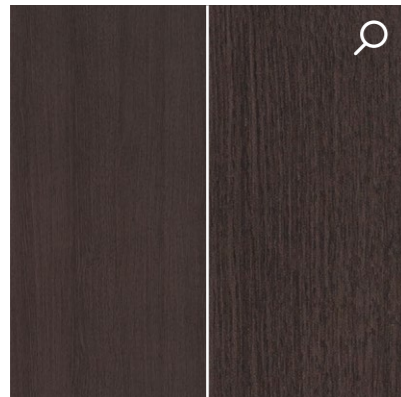

WENGE

## HPL



GRAPHITE RAL 7024

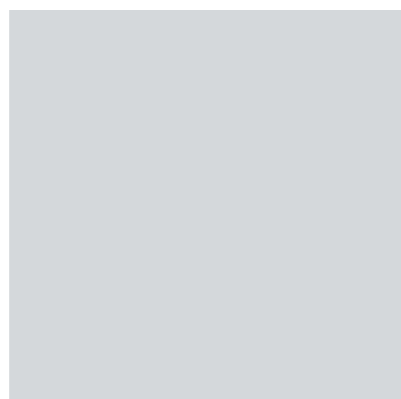

GRAY RAL 7047

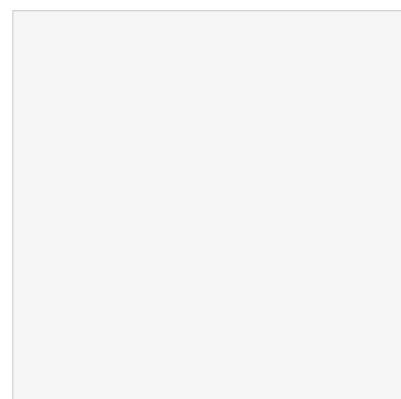

WHITE RAL 9003

## CPL

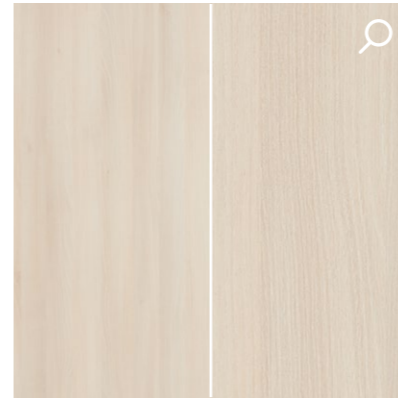

LIGHT ACACIA

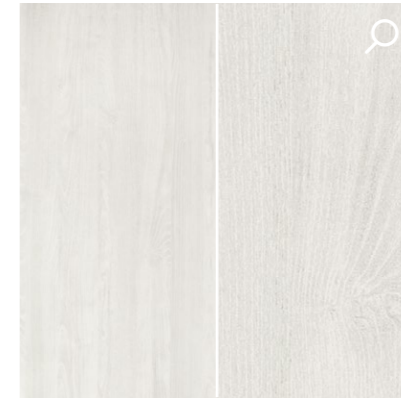

NORWEGIAN ASH

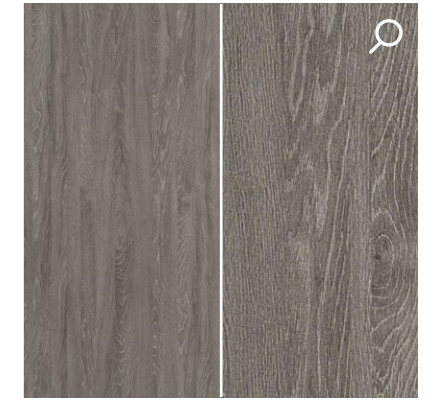

GRIGIO OAK

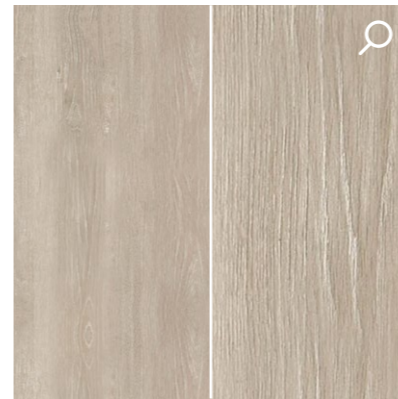

KENDAL OAK



ITALIAN WALNUT

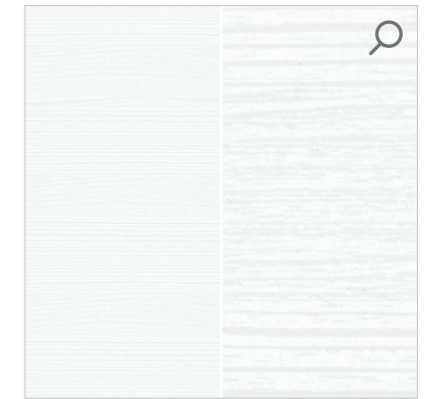

WHITE WITH HORIZONTAL STRUCTURE



GRAPHITE RAL 7024

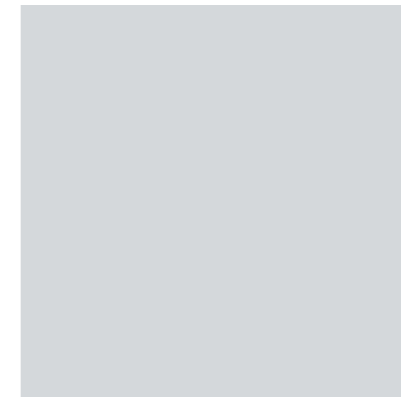

GRAY RAL 7047

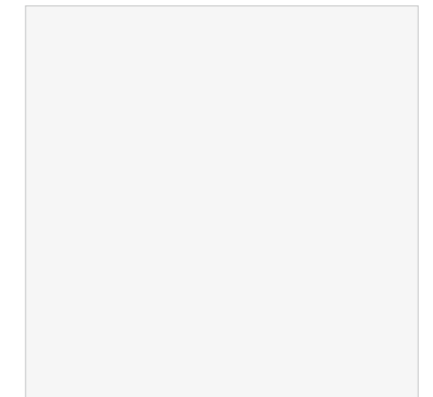

WHITE RAL 9003







# HPL UNI DECORS

Available upon individual enquiries. Details in the Customer Service department.

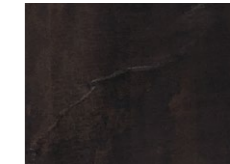
				
<b>Cotton</b> U113 – NCS S0907-Y30R	<b>Vibrant Yellow</b> U114 – NCS S1060-Y10R	<b>Citrus Yellow</b> U131 – NCS S0560-G90Y	<b>Sand Beige</b> U156 – NCS S1505-Y50R	<b>Curry Yellow</b> U163 – NCS S2060-Y10R
				
<b>Silicon Gray</b> U201 – NCS S3502-Y	<b>Came Beige</b> U216 – NCS S0502-Y50R	<b>Burgundy</b> U311 – NCS S5040-R	<b>Chinese Red</b> U321 – NCS S1580-Y90R	<b>Chili Red</b> U323 – NCS S3060-R
				
<b>Aubergine</b> U330 – NCS S7010-R30B	<b>Blue Horizon</b> U522 – NCS S1030-R80B	<b>Faience Blue</b> U525 – NCS S3060-R90B	<b>Indigo Blue</b> U599 – NCS S8505-R80B	<b>Kiwi green</b> U626 – NCS S3050-G40Y
				
<b>Lime Green</b> U630 – NCS S1060-G40Y	<b>Niagara Green</b> U646 – NCS S5030-B30G	<b>Cashmere</b> U702 – NCS S2005-Y60R	<b>Silky Gray</b> U707 – NCS S1500-N	<b>Light Gray</b> U708 – NCS S2000-N
				
<b>Stone Gray</b> U727 – NCS S4005-Y50R	<b>Dust Gray</b> U732 – NCS S5000-N	<b>Lava Gray</b> U741 – NCS S7005-Y20R	<b>Taupe Gray</b> U750 – NCS S2005-Y20R	<b>Pearl Gray</b> U763 – NCS S2500-N
				
<b>Cubanite Gray</b> U767 – NCS S6005-Y20R	<b>White Gray</b> U775 – NCS S1000-N	<b>Artic Gray</b> U788 – NCS S4500-N	<b>Velvet Black</b> U899 – NCS S8500-N	<b>Gray Onyx</b> U960 – NCS S6500-N
				
<b>Graphite Gray</b> U961 – NCS S8000-N	<b>Diamond Gray</b> U963 – NCS S7500-N	<b>Black</b> U999 – NCS S9000-N	<b>White</b> W911 – NCS S0502-G50Y	<b>Platinum White</b> W980 – NCS S0300-N
				
<b>Premium White ST22</b> W1000 – NCS S0500-N	<b>Premium White solid</b> W1001 – NCS S0500-N	<b>Alpine White</b> W1100 – NCS S0502-R50B		

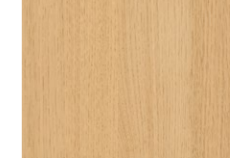
# HPL WOOD DECORS

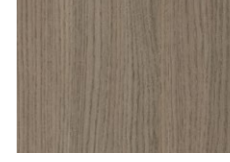
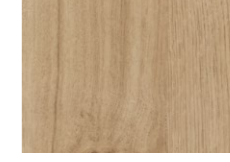
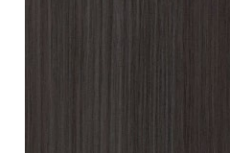
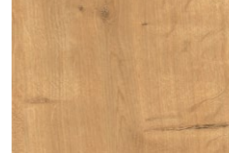
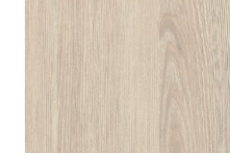
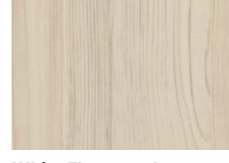
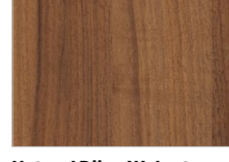
Available upon individual enquiries. Details in the Customer Service department.

				
<b>Dark Gray Chicago Concrete</b> F187	<b>Light Concrete</b> F274	<b>Metallic Inox</b> F500	<b>Aluminium</b> F509	<b>Black-Gold Metal Slate</b> F629
				
<b>Gray-Beige Bamenda</b> H1115	<b>Natural Bardolino Oak</b> H1145	<b>Gray Arizona Oak</b> H1150	<b>Navarra Ash</b> H1250	<b>Natural Branson Robinia</b> H1251
				
<b>Truffle Branson Robinia</b> H1253	<b>Light Lakeland Acacia</b> H1277	<b>Natural Wild Oak</b> H1318	<b>Light Sorano Oak</b> H1334	<b>Graphite Denver Oak</b> H1387
				
<b>Ellmau Beech</b> H1582	<b>Verona Cherry</b> H1615	<b>Lincoln Walnut</b> H1714	<b>Mali Wenge</b> H3058	<b>Shorewood</b> H3090
				
<b>Gray Corbridge Oak</b> H3156	<b>Vicenza Oak</b> H3157	<b>Gray Vicenza Oak</b> H3158	<b>Natural Kendal Oak</b> H3170	<b>Anthracite Finition Metallic</b> H3190
				
<b>Brown Finition Metallic</b> H3192	<b>Natural Hamilton Oak</b> H3303	<b>Gray Nebraska Oak</b> H3332	<b>Natural Cordbridge Oak</b> H3395	<b>White Aland Pine</b> H3430
				
<b>Polar Aland Pine</b> H3433	<b>White Fleetwood</b> H3450	<b>Champagne Fleetwood</b> H3451	<b>Gray Lava Fleetwood</b> H3453	<b>Natural Pacific Walnut</b> H3700
				
<b>Natural Hickory</b> H3730	<b>Natural Dijon Walnut</b> H3734	<b>Natural Mandal Maple</b> H3840	<b>Premium White ST19</b> W1000_ST19	





**Classen-Pol S.A.**

ul. Wyzwolenia,  
44-292 Zwonowice k. Rybnika  
phone: +48 (32) 429 20 00

e-mail: [biuro@classen.com.pl](mailto:biuro@classen.com.pl)

[www.classen.pl](http://www.classen.pl)



YOUR POINT OF SALE

The catalogue does not constitute an offer within the meaning of commercial law. Classen-Pol Sp. S.A. reserves the right to change and improve the products presented in this publication without prior notice. Information contained in this catalogue is correct at the time of publishing.

Colours presented in this catalogue may differ from the products that are on sale.

Art. no. 60010455 | CLASS. 04.2022/EN



5 907528 425504